

# *A Guide To Using Orton Pyrometric Cones*



figure 1

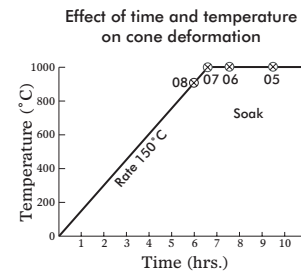

figure 3

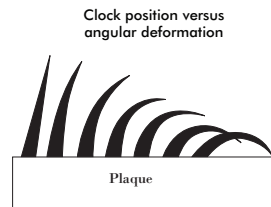

figure 5

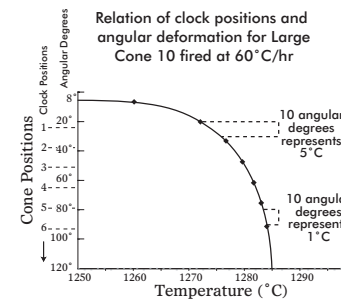

figure 7

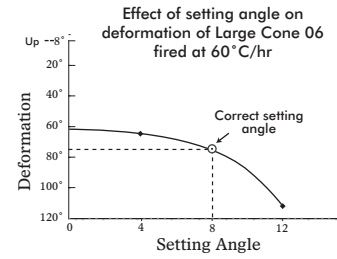

figure 9

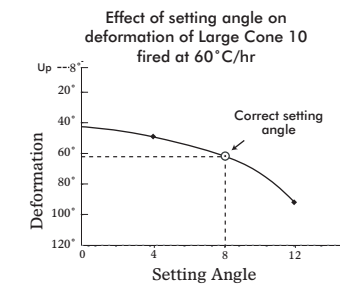

figure 11

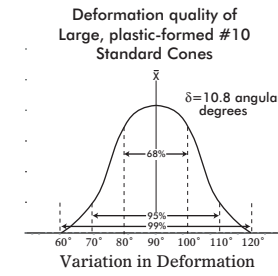

figure 13

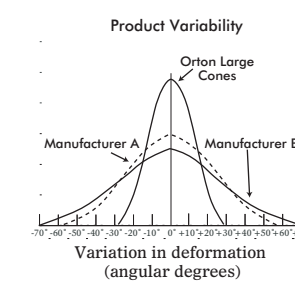

figure 15

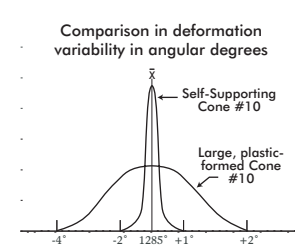

figure 2

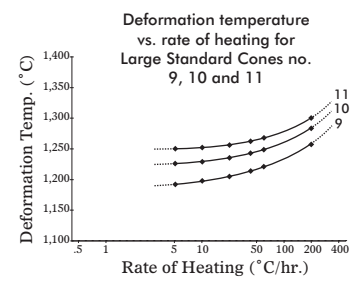

figure 4

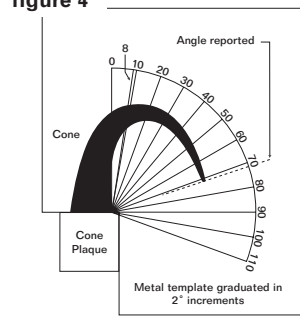

figure 6

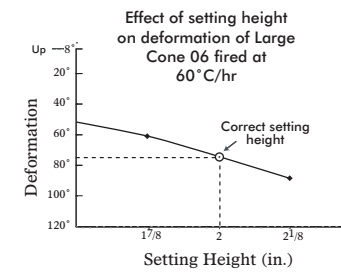

figure 8

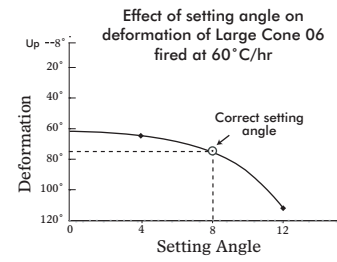

figure 10

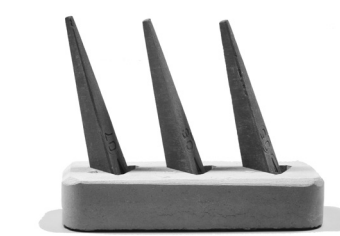

figure 12

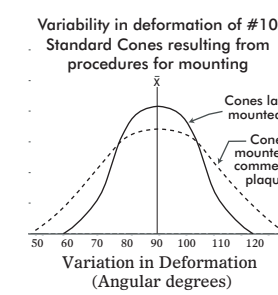

figure 14

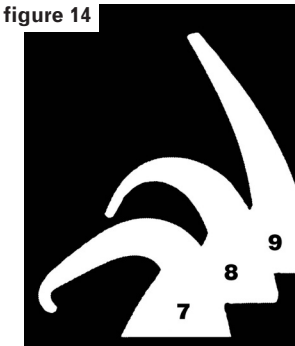

figure 16



## WHAT ARE ORTON PYROMETRIC CONES?

Developed by Edward Orton Jr. in 1896, Pyrometric Cones are used to measure the effects of both time and firing temperature inside a ceramist's kiln. In the ceramics industry, the combined effect of temperature and time is called "heatwork" and is one of the critical aspects of successful pottery and ceramics. When used correctly, Orton Pyrometric Cones are sensitive devices capable of indicating differences in heatwork with a remarkable degree of accuracy.

Made from over 100 carefully controlled compositions containing compounds similar to the ware, pyrometric cones bend (deform) in a repeatable manner over a temperature range of 50°F or less. The cones will soften and bend as glass forms while attaining the desired temperature and as the temperature and time of the firing continues.

Orton manufactures Large, Small, and Self-Supporting Cones. Large Cones are used industrial firms and by potters alike. The original "Standard" developed by Edward Orton Jr. in 1896, Large Cones measure 2½ in. (approx. 6.35 cm) high.

Small Cones measure approx. 1½ in. (2.86 cm) high and are composed similarly to Large Cones. Small Cones were designed to be used in kilns with limited space. Large and Small Cones require some means of support to achieve the correct mounting angle and height.

Self-Supporting Cones also measure 2½ in. (approx. 6.35 cm) high, and have the correct height and angle of mounting is already built into the cone. This makes it a simple but accurate way for the user to correctly and consistently reproduce firings.

## WHY USE ORTON PYROMETRIC CONES?

Orton Pyrometric Cones reliably and accurately measure the combined effects of both time and temperature and can be used for the following purposes:

- To determine if the desired amount of "heatwork" was delivered to the product,
- Data measured by cones can be entered into a statistical software program to provide SPC control charts,
- To measure kiln temperature uniformity,
- To monitor kiln atmosphere conditions during firing,
- To provide visual evidence of fired products' treatment through the accumulation of cones fired in the same runs

## HOW DO ORTON PYROMETRIC CONES WORK?

Pyrometric cones will "bend" or deform with the angle of the cone's tip creating an arc that curves downward. The amount the tip bends can be related to the hands of a clock and the end point temperature is reached when the cone bends to a 90° angle. The tip of the cone will bend slowly at first, but as the effects of heat over an extended time take place, the cone bends more rapidly.

Figure 1 illustrates the combined time-temperature effect of a uniform firing of a series of Large Cones number 08, 07, 06 and 05. (Orton recommends using a three-cone system for all your firings, with a guide cone, a firing cone and a guard cone. Four cones can also be used.)

At a uniform firing in an electric kiln at 150°C/hr, Cone 08 has deformed to the point of where the tip was even with the base (955°C). At 984°C, Cone 07 deformed to the same point. After one

hour of "soaking" (exposure), Cone 06 deformed and Cone 05 deformed after three hours of soak.

Since time and temperature are important factors in cone deformation, the rate of heating will influence the cone's deformation temperature. Figure 2 is an example of three Large Cones fired simultaneously at six different heating rates. As the rate of heating increased, the temperature required to reach the "End Point" temperature also increased. This relationship holds true for most ceramic products and glazes and a good example of why temperature alone is not enough to ensure proper maturation or firing conditions.

A system of describing cone deformation based on "clock positions" has evolved based on the observation of the cone's tip position in relation to an imaginary clock face. Figure 3 shows the "clock-like" deformation of Orton Pyrometric Cones that allows the operator to describe the cone's actual angular deformation in relation to its original vertical position. Figure 4 is an example of a commonly employed template, marked-off in two angular degree increments for the measurement of the cone's deformation. In this example, the value of deformation of 72° "angular" would be the reported result or end point.

Figure 5 illustrates the clock system of deformation description or bending interval recording during the firing process. It is readily apparent that this bending is not linear and must be kept in mind by the operator during the firing.

## IF I USE THERMOCOUPLES, WHY USE CONES?

Simple, easily handled and installed, thermocouples are the most commonly used temperature indicators in industry. A thermocouple registers the temperature "measured" at its tip, a single point in space and time. A thermocouple cannot

determine "heatwork" and without the cumbersome task of running an array of "traveling thermocouples" on a special kiln car, a thermocouple cannot provide information about the uniformity of heat distribution within the kiln cross-section.

The cost-savings of using Orton Pyrometric Cones regularly far outweigh the cost of the cones and increases the assurance of high quality ware.

## DETERMINING THE CONES TO USE

To determine the proper range of cones to be used, first determine:

- Maximum firing temperature desired
- Hold or "soak" time at max temperature
- Type of kiln atmosphere
- Heating rate during last 200°C ramp

Using this information, establish the general firing range by:

1. Using an Orton temperature equivalents chart, find the cone number for the heating rate and maximum temperature, closest to your actual firing conditions. (This will be your "Firing Cone".)
2. If there is a "soak" or time hold at maximum temperature, increase the "Firing Cone" by one cone hotter for a one hour soak; two cones hotter for three hours of soak; and three cones hotter for nine hours of soak.
3. If the kiln has a control thermocouple located in the crown (Top) of the kiln, lower the "Firing Cone" by one cone since the crown is usually much hotter than the bulk of the load where the cones will be set.
4. For the test run, utilize two "Guide" (Cooler)

Cones and one "guard" (Hotter) Cone around the "Firing Cone."

(In small kilns with a fast firing rate, approx. 300°C/Hr. or more, it may be necessary to use Orton's Small Cones which can be heated more rapidly without adverse effect.)

## WHY USE ORTON'S SELF-SUPPORTING CONES?

Two critical aspects common to the proper use of all Pyrometric Cones is mounting cones at the correct setting height and angle and doing so can cause the operator to expend much time and labor.

"Height Setting" impacts cone deformation dramatically. Figure 6 and 7 show the effect of setting height against the angular deformation of various height cones. The cones at the highest heights deformed the most and the cones mounted at the lowest heights deformed least.

"Angle Setting" also significantly effects cone deformation as shown in Figure 8 and Figure 9. To illustrate this, a similar procedure was used in "Height Setting", where several cones were mounted at various angles with all other factors remaining constant. Cones set less than the designed 8° angle deformed less than those set at 8° angle. The Large cones in Figure 10 are correctly mounted at an 8° setting angle and at approx. 5.08 cm (2 in.) setting height.

The need for dependence upon the human factors for careful mounting has been eliminated by Orton's introduction of Self-Supporting Cones. Orton's revolutionary Self-Supporting Cone has the correct mounting height and angle built into the supporting base of the cone and allows users to have consistent, reproducible and successful firings.

## HOW DO ORTON'S SELF-SUPPORTING CONES WORK?

Orton Foundation's patented product design, seen in Figure 14, shows the base of the cone acts as its own base support during firing. Orton engineers studied the problem of inconsistencies in results caused by inaccurate mounting and developed the Self-Supporting Cone. The fulcrum around which the cone bends is precisely controlled through careful design and manufacturing.

Figure 15 shows a frequency distribution curve for Self-Supporting Cones as compared to that of Orton's regular Large Cones, mounted in the recommended manner. The variation in angular deformation has been virtually eliminated by the patented Self-Supporting Cone design.

## ARE ORTON PYROMETRIC CONES REALLY TOP QUALITY?

The consistent performance demonstrated in Figure 16 is a better answer of our quality and dedication. It shows by photograph the typical consistency of 48 Orton Self-Supporting Cones fired simultaneously.

## HOW DO I FIND OUT MORE ABOUT ORTON PYROMETRIC CONES?

You can visit the Orton website at [www.ortonceramic.com](http://www.ortonceramic.com) and go to the section on Products for Firing where you will find a great deal of information on cones and their use or you can call us at (614) 895-2663.

