



SUMMER



GUIDE

Volume 2

Table of Contents

Welcome Letter	3
Summer Camp Simplified	4
Week 1: Fairy Tale Magic	6
Crystal Ball Glass Bracelet.....	8
Mirror, Mirror on the Wall	9
Fairy Land.....	10
Enchanted Fairy Garden	12
Magic Kingdom.....	14
Dreamcatcher	16
Material List.....	18
Week 2: When I Grow Up	19
Out of this World	21
Writer’s Block.....	23
Night Night Light.....	24
Game it Up!	26
Furry Friends	28
Space Traveler	29
Yummy Fun	31
Sweet as Pie	33
Bubble Experiment	34
Tie Dye Lab Coat	35
Material List.....	36
Week 3: Art Around the World	37
Krazy Kandinsky	39
Oh, Starry Night	41
Seeing Double.....	43
Mod Mosaic.....	44
Perfect Pointillism.....	46
Mirror, Mirror.....	48
Creativi-Tree.....	50
Material List.....	52
Week 4: Just for Tweens	53
Totally Tie-Dye	55
Geometric Magic.....	56
BFF	58
Totally Charming.....	59
Monogram Me	60
Glamour Shots	61
Selfie Expression.....	63
Material List.....	65
Project Games & Templates	66

Welcome to our second annual Summer Camp Resource Guide!

Hi there!

We're so glad you've found this exciting resource. This year, the BI team is excited to bring back our wildly popular Summer Camp Guide with all new projects to help save you time, money, and stress. We hope you find our guide to be fun, inspiring & easy to use. Most of all, we hope it helps motivate you to plan your best summer ever!

Before we dive in, we'd like to share just a few notes about the program to help you get started.

1. Included in these pages are four complete weeks of camp. We've defined a "week" of camp to be 5 days that are 3 hours each. Every program is a little different, and we've tried to maintain a level of flexibility that allows you to adjust the sessions to fit your studio.
2. For each week, you'll find a suggested schedule, quick tips and time filling activities, project guides, and a material list for simple ordering.
3. Each week is structured around 1-2 multi-day projects with a few smaller projects mixed in. For any project that requires more than one day of work, you'll find a "Suggested Session" section in the project guide. We've broken each large project into manageable pieces to allow time for decorating, drying, firing, etc. As with every other part of our guide, we hope you'll feel free to adjust these sessions to support your needs.
4. In addition, we've structured each week to give you the ability to fire and return any projects by the end of the week. Because of this, we've grouped fired or multi-stage projects towards the beginning of the week to allow more time to complete. For any project that needs to be fired, the day it should be fired will be noted after the project on the schedule. If you follow our guidelines, you'll be able to send the entire set of projects (fired and non-fired!) home with the campers at the conclusion of the camp week. Sweet simplicity!
5. We've included a little bit of everything in our projects. We believe the best summer camp projects are economical (About \$4.00 per project per child), creative (techniques and designs), and offer the child several different mediums to work with. We understand there are many different ways to approach your studio camps, but we feel that providing a mixture of fired and non-fired options allows for the most fun and flexibility. Who doesn't love that?!

As you begin your summer camp planning process, we hope that this guide serves as a useful resource. As our mission states, "The Bisque Imports vision is to be an energetic and sustainable resource for ceramic studios worldwide." We exist to help you! Let us know how we can help you plan your best summer yet. We'd love to hear from you!

Have fun!

--The Bisque Imports Crew

Our 15 Tried and True Summer Camp Tips

Camps can be a wonderful opportunity to attract new business to your studio. Done well, they can be the beginning of a positive relationship with a repeat customer. But without proper planning, camps can quickly become a less than positive experience for everyone involved. Don't let this be you! We've compiled our fifteen tried and true tips for a Rockin' Camp. Let's get started!

1. It's never too early to start planning. Many find the slow winter months to be the best time to knock out summer planning. Take advantage of new year's sales and stock up on items you know you'll need once summer arrives.

2. Keep a notebook nearby during camps. Write down notes to yourself about what works and what doesn't. If you're not teaching the camp yourself, spend a little time getting the necessary feedback from your counselors. Once the dust settles on a busy summer, you'll be able to revisit these notes and improve your program for next year.

3. Samples sell! Most parents will want to know exactly what their child will be working on during their camp session. Have the samples ready before you start your marketing, and you'll be amazed how much quicker you fill up.

4. Don't be afraid to ask for suggestions! During our own event planning, we like to ask former attendees and trusted advisors for ideas on how to improve. Get camp parents involved in improving your program, and they're more likely to feel invested in future years! Don't overlook your staff, either. Often times, they'll be closer in age to your campers than you are. They'll likely have valuable insight on popular trends and interests.

5. Set your budget and stick to it. Price everything required to keep summer camps running smoothly--from staffing to snacks--and factor it into your budget. If you only factor the cost of the projects into the price of camp, you may be overlooking some of your larger expenses.

6. Nothing can replace a well crafted schedule. Plan your week around a few larger, multi day projects. Then fill in with projects that support the theme of the week (and stick to your budget!) |

7. Never underestimate the power of a few time fillers. While we suggest switching up the schedule every week to keep things fresh for returning campers, these time fillers are so simple that you can reuse them week to week. Have 4-6 in your back pocket for times when you're running ahead of schedule. Also have a few activities available for the super fast artist. (Every week has one!) This will allow the other campers to stay on task without being distracted by those that finished early. If all else fails, keep a tub of markers, kid scissors, and construction paper around for some good old-fashioned paper crafts.

8. Create open lines of communication with your parents. Whether this is through an email list or a phone call, make sure you have ways to gather information on their child and vice versa. You'll need to be able to communicate important details in the days leading up to the camp, and inform them of any changes.

9. Consider letting a staff member teach. Many children respond better to counselors that are closer to their age. Not only that, but you'll find that some parents prefer this, too. We suggest picking several of your top staff members for the job. It's best to have a lead as well as an assistant that will work the store. Make sure that your staff is aware and comfortable with all of the responsibilities. In a given hour, they may be expected to teach a group, clean a spill, arrange snacks, correspond with parents, or assist in another area of the store. Make sure they're up for the job! It may be helpful to work the first day with them to properly demonstrate your expectations.

10. Make sure your staff is trained in every step of your summer camp process--whether you're teaching it or not. You never know when you'll need to rely on them! This includes the registration process--a nervous employee will not be able to sell a camp registration for you. Consider adding an incentive for the employee with the most sign ups.

Our 15 Tried and True Summer Camp Tips

11. Encourage repeat customers by varying your schedule.

This is key--customers won't sign up for multiple weeks if the program is the same. While this requires more preparation, the payoff can be huge. Some overlap is acceptable, but avoid repetition if you hope to book repeat campers.

12. Try to have all the projects completed by the end of the week.

You won't believe how much simpler this will make your life--as soon as the campers walk out your door, all you have to do is clean up the table and get ready for the next group! Not only does it simplify the guessing game that can happen once you're left with 25 identical clay coil pots, but your parents will really appreciate this during a hectic summer. Try grouping fired projects in the early days of camp, and focus on acrylics, mosaics, and craft projects at the end of the week. This tip will take a little extra thought, but it will make all the difference in the world.

13. Schedule your camps around your business, not the other way around.

Your camps are meant to act as a bolster for your business, not a speed bump! Ask yourself the question, "Is this going to be a problem on a busy summer day?" If the answer is yes, go back to your process and see how to improve. This may mean shifting the scheduled times, or creating an area where campers can be out of the flow of normal traffic. Believe it or not, one of the best sales tools for your camps is seeing a smoothly run camp in action! If customers in the store see an organized camp full of kids having fun, they'll want to sign their child up, too!

14. Promote as much as possible.

Starting in February, staple a flyer to every receipt that leaves your building. (Yes, this requires you to have your ducks in a row by February!) If you're spending the months planning instead of promoting, you'll have a wonderful camp with no campers. Utilize social media, emails, and local outlets to promote your programs however possible. Another tip is to offer a sibling or friend discount for signing up two or more campers at once. You may even try offering referral cards to parents. If their referral signs up, both parties receive a discount.

15. Have fun!

A fun and lively camp program will ensure your success. There's no better advertisement for your business than happy campers. The wonderful thing is that the parents of those happy campers will tell others. With time, your rockin' program will grow through word of mouth!

Few things in your studio will prove to be as challenging and rewarding as camp programs. Take the necessary steps to start planning your best summer EVER! When the first campers arrive, you'll be glad you did.

Good luck!



Fairy Tale Magic

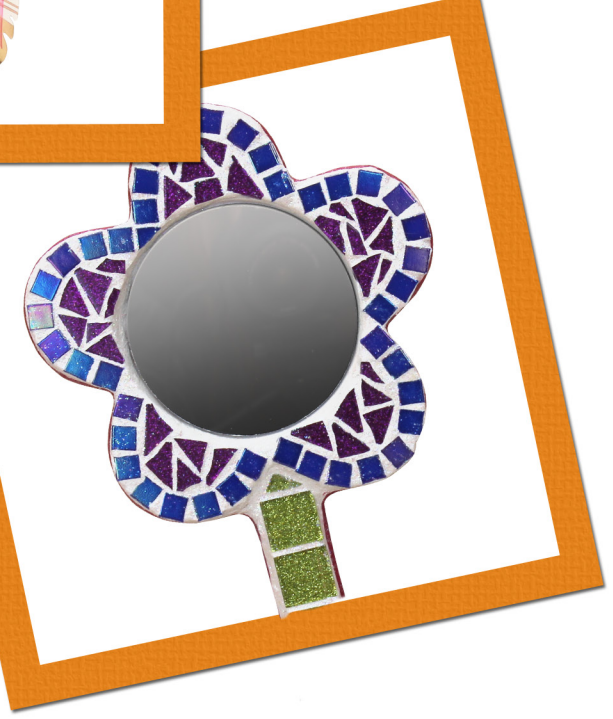



Overview

SCHEDULE

Monday

- 9:00-9:30 : Drop off, decorate name tags & gift bags
- 9:15-9:30 : Introductions : campers pick a Fairy/Gnome name
- 9:30-10:15 : Fairy Land: Paint Whimsy Mushroom (Fire by Thursday)
- 10:15-10:45 : Clean up, snack
- 10:45-11:15 : Fairy Land: Paint Little Trixie Mighty Tot (Fire by Thursday)
- 11:15-12:00 : Crystal Ball Bracelet: Assemble Crystal Balls on 8" Sq. Tile (Fire by Friday)

Tuesday

- 9:00-9 :15 : Drop off
- 9:15-10:00 : Magic Kingdom: Paint background and let dry
- 10:00-10:30 : Clean up & Snack
- 10:30-11:15 : Finish painting canvas
- 11:15-12:00 : Sweet Dreamer: Paint 7" Round Tile with acrylics

Wednesday

- 9:00-9:15 : Drop off
- 9:15-10:15 : Sweet Dreamer: Make paper feathers with scrapbook paper and acrylics
- 10:15-10:30 : Clean up
- 10:30-10:45 : Snack: Magic Wand Fruit Kabobs
- 10:45-11:30 : Assemble dream catcher with craft supplies
- 11:30-12:00 : Thank you cards for parents

Thursday

- 9:00-9:15 : Drop off
- 9:15-10:00 : Add mosaic pieces to Princess Mirror
- 10:00-10:30 : Clean up, Snack
- 10:30-11:00 : Make paper crowns out of construction paper
- 11:00-12:00 : Assemble Fairy Garden with Whimsy Mushroom, Little Trixie, and craft supplies

Friday

- 9:00-9:30 : Grout mosaic
- 9:30-10:00 : Clean mosaic tiles off
- 10:00-10:30 : Paint sides and back of mosaic mirror with acrylics & sparkler
- 10:30-11:00 : Clean up, Snack
- 11:00-11:30 : Assemble Crystal Ball Bracelet
- 11:30-12:00 : Wrap up, package up projects

You'll notice we've included thank you notes in each schedule. This is a great way for the children (and your studio!) to thank the parents for enrolling their child. Have a variety of crayons, paper, and decorating supplies on hand for neat cards. Here's how to create a "pop up" card.

1. Fold 8.5" x 11" sheet of paper in half, "hamburger style."
2. Make two 2" cuts 2" in from the sides on the folded edge. Don't cut all the way through.
3. Open the sheet and invert the fold, pushing the cut area forward. The campers can then decorate the the "pop up" area with other cute designs or lettering. Tip: attach another piece of paper to the outside to hide the cut out area.

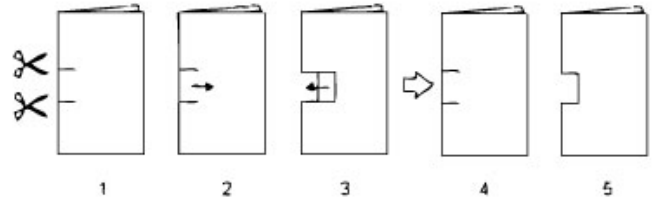

MAGICAL SNACK IDEA:

Magic Wand Fruit Kabobs: Make this fun and healthy snack for campers on Wednesday! Combine a combination of strawberries and grapes (check for allergies!) onto a wooden skewer. For a neat finishing touch, use a cookie cutter to cut star shapes out of watermelon.

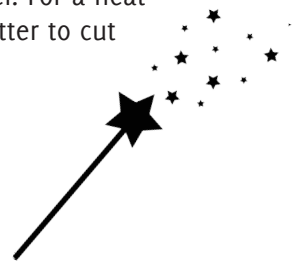



Crystal Ball Glass Bracelet

Design courtesy of Bisque Imports

Let campers transform scrap glass into magical crystal ball bracelets (or add these baubles to key chains, wind chimes, and more!)

MATERIALS

- 956 8" Square Tile
- CFKITF Frit Kit - Fine
- D15481 Aleene's Glass & Bead Glue
- GBITS100 Clear Transparent Bits
- SP-860 Gunmetal Linked Bracelet
- ST356 Wheel Mosaic Cutter
- ST540 Thinfire Shelf Paper

SUPPLIES

- Angled Straw
- Nipping Basket
- Non-Aerosol Hairspray
- Q-Tip
- Silver Sharpie
- Small Mixing Cups

INSTRUCTIONS

- Place a sheet of Thinfire shelf paper onto the 8" Square Tile to create a portable assembly surface.
- Use an angled straw to scoop and mix a small amount of assorted fine frit into a small cup, then mix.
- Pour a dime-sized amount of the frit mixture onto the thinfire paper. Use a Q-tip to mold the frit into an ant hill shaped pile.



- Use a Wheel Mosaic Cutter to nip Clear bits into quarters. Place one quarter piece onto the frit pile.
- Repeat this process, using an assortment of different frit mixtures, until at least twelve different piles have been made and capped.
- Spritz frit piles with non-aerosol hairspray to secure in place.
- Write the camper's name with a Silver Sharpie on the Thinfire. Fire to a Full Fuse using the firing schedule provided:

Seg:	Ramp	Temp	Hold
1	300	1000	.30
2	350	1465	.15
3	9999	1050	.60
4	280	800	.10

- Once fired, use pinpoints of Aleene's Glass & Bead Glue to attach one frit crystal ball to each round disk on the bracelet.



Mirror, Mirror on the Wall

Design courtesy of Bisque Imports

Adding mosaic elements to bisque is a great and affordable way to try mosaics out in your store.

MATERIALS

- 1322** Princess Mirror
- 8301** E-6000 Adhesive
- BIM106** Leafy Pebble Assortment
- BIM153** Midnight Water Iridescent Tiles 10 mm
- BIM471** Shamrock Glitter Mosaic Tiles 20 mm
- BIM473** Aubergine Glitter Mosaic Tiles 20 mm
- BIM70212-0003** White Grout
- BIM72946-0006** Weldbond
- OS447** Magenta
- RAQUA144** Aqualon Assortment
- SG880** Crystal Sparkler
- ST356** Wheel Mosaic Nipper

SUPPLIES

- Latex Gloves
- Paper Towels
- Plastic Spoon (to mix grout)
- Small Disposable Bowl (for grout mix)
- Water

INSTRUCTIONS

1. Using Weldbond as adhesive, adhere one Leafy Pebble to the base of the handle.
2. Along the mirror handle, adhere Shamrock Glitter tiles. If needed, use the Wheel Mosaic Nipper to nip pieces to desired size.



3. Adhere Midnight Water Iridescent tiles around the border of the flower shape.
4. Fill in the remaining areas of the flower with small nipped pieces of Aubergine Glitter tiles.
5. Then, follow the grouting instructions found on page 37 to finish using White Grout.
6. Allow grout to dry to the touch. Then, use a paintbrush to paint the edges and back of the mirror with Magenta. Let dry.
7. Use a paintbrush to apply 1 coat of Crystal Sparkler over project surface and edges. Let dry.
8. Attach mirror insert to project with E-6000 Adhesive.

Money saving tip - nip large mosaic pieces into smaller bits for campers to get even more out of each bag of tiles!



Fairy Land

Design courtesy of Bisque Imports

This whimsical fairy set will delight your camper's creative sides! Add in a mix of mushrooms, gnomes, and flowers to personalize your sample.

MATERIALS

- 1123** Trixie or **4365** Little Trixie Mighty Tot
- 1574** Whimsy Mushroom
- CN111-8** Light Delft
- CN221-8** Light Blush
- CN232-8** Bright Briarwood
- CN244-8** Really White
- CN272-8** Bright Jade
- CN282-8** Bright Brown
- CN292-8** Bright Purple
- CN341-8** Light Pink
- CN373-8** Dark Honeysuckle
- CN501-8** Neon Yellow
- CN507-8** Neon Red
- FD258** Pure White
- RAQUA144** Aqualon Assortment

SUPPLIES

- Black Washable Marker
- Sponge
- Water

INSTRUCTIONS

Lightly wipe each piece with a damp sponge to prepare for painting.



Whimsy Mushroom:

1. Use a black washable marker to sketch a door and two windows onto the mushroom base.
2. Use 3 coats of Bright Brown to paint the base of the mushroom. Leave door and each window unpainted.
3. Using the tapered end of a paintbrush handle, scratch out wood grain lines throughout the Bright Brown painted base area.
4. Paint the door with 3 coats of Light Delft.
5. Paint each window with 3 coats of Neon Yellow. Let dry.
6. Paint the underside of the mushroom cap with 3 coats of Bright Purple. Accent with Bright Briarwood brushstrokes.



Fairy Land Continued

5. Paint the backside and outer lining of each wing with Dark Honeysuckle.

6. With a detail brush, add Light Delft dots to each wing. Add additional dots to the fairy's eyes, hemline, and neckline. Let dry.

Once completed, dip each piece in Pure Brilliance and fire to Cone 06.

7. Paint the top surface of mushroom cap with 3 coats of Neon Red. Let dry.

8. Using a detail brush and Bright Briarwood, paint the door frame, hinges, and door knob. Paint each window frame, as well as stripes on the door with the same color.

9. Let dry. Tip: Mixing Pure White and Really White allows you to paint white on top of darker colors with ease.

Trixie:

1. Paint the face, arms, and legs with 3 coats of Light Blush.

2. Paint the fairy's hair with Neon Yellow.

3. Paint the fairy's dress with Bright Jade.

4. Use a sponge to sponge each wing with Light Pink.



Enchanted Fairy Garden

Design courtesy of Bisque Imports

Our Magical Fairy Garden combines the project from Fairy Land with other fun components to create the full experience! Create some or all of these pieces for an adorable final result.

MATERIALS

- 956** 8" Square Tile
- 1123** Trixie or **4365** Little Trixie Mighty Tot (painted)
- 1574** Whimsy Mushroom (already painted)
- 8301** E-6000 Adhesive
- BIM102** Gray-dient Pebble Assortment
- D31210** Aleene's Matte Decoupage
- OS432** Ivory
- OS450** Lilac
- OS471** Medium Brown
- OS473** Black Brown
- RAQUA144** Aqualon Assortment

SUPPLIES

- Craft Moss
- Elmer's Clear Gel Glue
- Hemp Cord
- Latex Gloves
- Scissors
- Sponge
- Tape
- Water
- Wooden Craft Sticks



INSTRUCTIONS

1. Paint the entire tile with Black Brown.
2. Use a sponge to densely sponge tile surface with Medium Brown. Let dry.
3. Use E-6000 adhesive to adhere the Whimsy Mushroom fairy house to one corner of tile.
4. Arrange an assortment of Gray-dient pebbles to create a stone path. Adhere in place with E-6000.
5. Cut two strands of hemp cord and adhere along each side of stone path.
6. Use scissors to cut wooden craft sticks in half. Paint the front and backside of each craft stick with Ivory. Let dry.
7. Arrange half-cut wooden craft sticks vertically side-by-side to create a picket fence.



Enchanted Fairy Garden Continued



Your campers will love this project!

8. Cut four additional strands of hemp cord. Adhere two strands horizontally across one side of the picket fence. Once dry, flip fence over and repeat on opposite side. Position hemp cords in place with tape until dry.

9. Use E-6000 to adhere the wooden picket fence upright along the back edge of tile. Use tape to secure fence as it dries.

10. Adhere three half-cut craft sticks to create a small sign. Paint the front and backside of vertical sign base with Ivory. Paint the horizontal sign with Lilac. Let dry.

11. Once dry, use a detail brush and Black Brown to paint "Fairy Garden" on the sign. Set aside to dry.

12. Adhere bunches of craft moss to the remaining ground area of tile. To adhere, coat surface with Elmer's Clear Gel Glue then press moss firmly onto tile. As you work, wear latex gloves to keep your hands clean!

13. Use a paintbrush to generously dab Aleene's Matte Decoupage over the moss-covered areas. If needed, trim the moss along the tile edges with scissors.

14. Use E-6000 to adhere the Trixie to the tile surface.

15. Adhere the completed fairy garden sign upright to tile surface. For greater stability as it dries, position the sign leaning against another object. Let project dry completely.



Magic Kingdom

Design courtesy of Bisque Imports

The quickest way to make parents and campers happy? Handprint art! Transform those precious prints into castles, dinosaurs and more with this fantastical design!

MATERIALS

- AA7010** Canvas Panel 12" x 12"
- AS959** Duncan Hi-Gloss Sealer
- OS431** White
- OS435** Dark Yellow
- OS449** Bright Red
- OS457** Medium Blue
- OS463** Medium Green
- OS464** Bright Green
- OS467** Light Brown
- OS476** Black
- OS551** Cotton Candy
- OS556** Lemon Grass
- OS558** Miami Pink
- OS569** Concord
- RAQUA144** Aqualon Assortment

SUPPLIES

- Pencil
- Sponge
- Water

INSTRUCTIONS

1. Lightly sketch a landscape background design onto the canvas with a pencil.



2. Paint the landscape and background with your choice of acrylic paint colors.
3. For this project, we used Medium Green, Bright Green, and Lemon Grass to paint a rolling hills landscape. Blend the colors to create varied shades of green for each hill.
4. Paint the sky with Medium Blue.
5. Sponge White across the sky in scattered places to create the look of clouds. Let dry.
6. Apply the first handprint along the uppermost hill, towards the upper right corner, in Cotton Candy.
7. Apply the second handprint along the lower hill, near the bottom left corner, in Bright Red.
8. Use Bright Red to paint the head, feet, and tail of the dragon on the Bright Red handprint.



Magic Kingdom Continued

paint a curving path that begins at the castle door and runs across two hill arches. Outline path with Black.

15. Paint each window with White.

16. Paint each tower flag with Concord. Use the same color to paint the base of the door and ruffles below the center tower.

17. Paint each window ledge with Concord. Use the same color, again, to outline each window.

18. Once your project is completed and fully dry, cover the canvas surface with a coat of Duncan's Hi-Gloss Sealer.

9. Use Concord to paint spikes along the dragon's head and backside, and scales along the neck. Use the same color to paint the underbelly, stripes along the nose, and stripes in between each finger print.

10. Use White to paint the dragon's eye. With Black, add a smaller dot on the eye.

11. Use a detail brush to accent and outline the dragon with Black. Add fire from the dragon's mouth with streaks of Dark Yellow and Bright Red.

12. To paint the handprint castle, use Miami Pink to paint a triangle at the tip of each finger print. Use the same color to paint the wall above the palm of the hand, and the border around the door.

13. Paint the door with Light Brown. Outline and accent the door using a detail brush and Black.

14. At the tip of each triangle tower, use Dark Yellow to paint a flag pole. Use the same color to

Looking for other fun hand and foot print ideas? Try creating a unicorn with a footprint, a butterfly from 2 hands, or an animal from a handprint!



Sweet Dreamer

Design courtesy of Bisque Imports

Keep dreams sweet with this adorable mixed media dream catcher!

MATERIALS

- 947** 7" Round Tile
- 8301** E-6000 Adhesive
- BIM364** Royal Richness Round Pebbles 12 mm
- OS435** Dark Yellow
- OS441** Dresden Flesh
- OS468** Deep Turquoise
- OS469** Light Turquoise
- OS569** Concord
- OS586** Ultra Marine
- RAQUA144** Aqualon Assortment
- SP-DF** Doodle Friends 12" x 12" Paper Pack

SUPPLIES

- Assorted Ribbon
- Glue Stick
- Hemp Cord
- Hole Punch
- Pencil
- Scissors
- String
- Tape
- Water

INSTRUCTIONS

1. Lightly wipe ware with a damp sponge to prepare surface for painting.



2. Around the border of the tile, paint large stripes using Deep Turquoise, Light Turquoise, Concord, and Ultra Marine. Let dry.
3. Add smaller stripes around border with 2 coats of Dark Yellow.
4. Paint the center circle, edges, and backside of tile with Dresden Flesh. Let dry.
5. Use E-6000 adhesive to glue Royal Richness pebbles in scattered spots around center circle edge, and one pebble in the center of the circle.
6. Cut out a strand of thick hemp cord and adhere around center circle. Let dry.
7. Cut a long strand of thin string. Adhere one end directly beside center pebble.
8. Weave the string around the various pebbles to create the center web of dream catcher. Once complete, adhere the end of the string around



Sweet Dreamer Continued

TIP: Drill holes and add string and beads to make it a plaque, or attach command strips to hang from a wall!

center pebble with a pinpoint of E-6000.

9. Add additional pebbles in scattered spots throughout woven web. Let dry.
10. On scrapbook paper or construction paper, sketch and cut out variously-sized feather shapes. Decorate with acrylics if desired. Create dangling feathers by punching a hole through one tip and adding string to hang.
11. Cut out an assortment of ribbon strands in various lengths.
12. Flip round tile over, then use tape or a glue stick to secure ribbon and feather designs so that they hang below dream catcher base. Layer the strands of ribbon to create more volume.



Material List

BISQUE

- 947 7" Round Tile
- 956 8" Square Tile
- 1123 Trixie or 4365 Little Trixie Mighty Tot
- 1322 Princess Mirror
- 1574 Whimsy Mushroom

PAINT

- CN031-8 Light Butternut
- CN111-8 Light Delft
- CN221-8 Light Blush
- CN232-8 Bright Briarwood
- CN244-8 Really White
- CN272-8 Bright Jade
- CN282-8 Bright Brown
- CN291-8 Light Purple
- CN292-8 Bright Purple
- CN293-8 Dark Purple
- CN341-8 Light Pink
- CN373-8 Dark Honeysuckle
- CN501-8 Neon Yellow
- CN507-8 Neon Red
- CN510-8 Earthen Moss
- FD258 Pure White
- OS431 White
- OS432 Ivory
- OS435 Dark Yellow
- OS441 Dresden Flesh
- OS447 Magenta
- OS449 Bright Red
- OS450 Lilac
- OS457 Medium Blue
- OS463 Medium Green
- OS464 Bright Green
- OS467 Light Brown
- OS468 Deep Turquoise
- OS469 Light Turquoise
- OS471 Medium Brown
- OS473 Black Brown
- OS476 Black

- OS551 Cotton Candy
- OS556 Lemon Grass
- OS558 Miami Pink
- OS569 Concord
- OS586 Ultra Marine
- SG880 Crystal Sparkler

CRAFT & SUPPLIES

- 8301 E-6000 Adhesive
- AA7010 Canvas Panel 12" x 12"
- AS959 Duncan Hi-Gloss Sealer
- D15481 Aleene's Glass & Bead Glue
- D31210 Aleene's Matte Decoupage
- RAQUA144 Aqualon Assortment
- SP-860 Gunmetal Linked Bracelet
- SP-DF Doodle Friends 12" x 12" Paper Pack
- ST356 Wheel Mosaic Cutter
- ST540 Thinfire Shelf Paper

WARM GLASS

- CFKITF Frit Kit - Fine
- GBITS100 Clear Transparent Bits

MOSAICS

- BIM102 Gray-dient Pebble Assortment
- BIM106 Leafy Pebble Assortment
- BIM153 Midnight Water Iridescent Tiles 10 mm
- BIM364 Royal Richness Round Pebbles 12 mm
- BIM471 Shamrock Glitter Mosaic Tiles 20 mm
- BIM473 Aubergine Glitter Mosaic Tiles 20 mm
- BIM70212-0003 White Grout
- BIM72946-0006 Weldbond



When I Grow Up



Veterinarian



Teacher

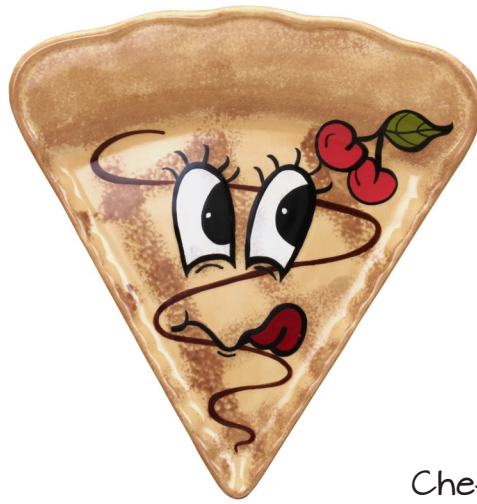

Chef

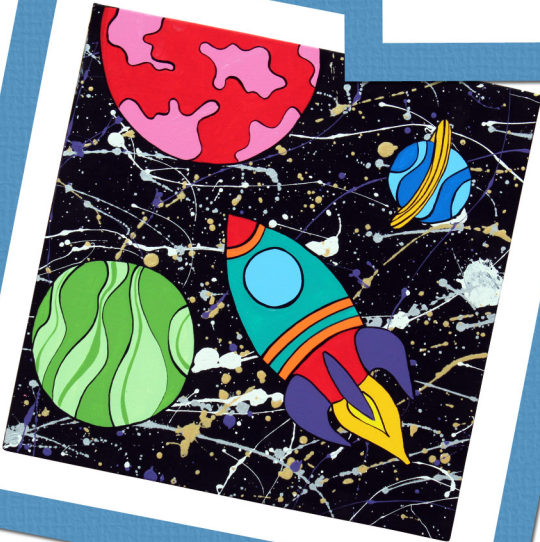

Astronaut

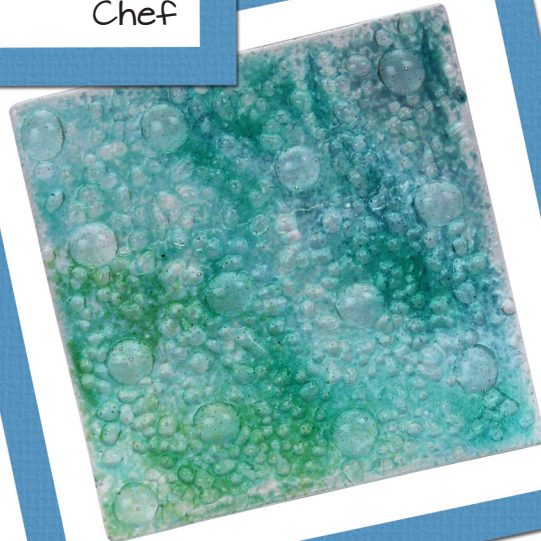

Scientist



Overview

SCHEDULE

Monday: Veterinarian

9:00-9:30 : Drop off, decorate name tags & gift bags

9:15-9:30 : Introductions

9:30-10:15 : Furry Friends (Fire by Friday)

10:15-10:45 : Clean up, snack

10:45-12:00 : Night Night Light (Fire by Friday)

Tuesday: Teacher

9:00-9:15 : Drop off

9:15-9:30 : Writer's Block: Paint 6" Tile with whiteboard background (Fire by Friday)

9:30-10:15 : Game it Up! (Fire by Friday)

10:15-10:30 : Clean up

10:30-10:45 : Snack : Milk & Cookies (read If You Give a Mouse a Cookie book)

10:45-12:00 : Space Traveler: Splatter paint background (dry/complete Friday)

Wednesday: Chef

9:00-9:15 : Drop off

9:15-9:30 : Play Pie Face dice game and sketch design onto plate

9:30-10:15 : Paint Sweet as Pie plate (Fire by Friday)

10:15-10:45 Snack: Apple Cookies & Sandwiches, play FUN FOOD BINGO

10:45-12:00 : Yummy Fun (Fire by Friday)

Thursday: Scientist

9:00-9 :15 : Drop off

9:15-10:00 : Tie Dye Mad Scientist Lab Coat

10:00-10:30 : Clean up & Snack

10:30-11:00 : Bubble Experiment (Fire by Friday)

11:00-12:00 : Out of This World plate & tag-along (Fire by Friday)

Friday: Astronaut

9:00-9:15 : Drop off

9:15-10:00 : Assemble mosaic pieces on Writer's Block whiteboard

10:00-10:30 : Clean up and snack, play hangman on game board

10:30-11:00 : Thank you cards for parents

11:00-11:45 : Finish Space Traveler canvas with acrylics

11:45-12:00 : Wrap up, package up projects

Gift Bag ideas: You'll notice that each week includes decorating gift bags and name tags at the beginning of the first day. Not only is this a great activity for campers during drop off, but it makes staying organized fun!

Have each camper decorate an inexpensive kraft paper bag. As they finish projects throughout the week, they'll be responsible for putting their completed work in their bags. By the end of the week, they'll have their personalized bag of artistic creations to take home!



This is a fun week because it allows campers to explore a variety of different sub themes. Try doing job trivia each day to teach the campers a little bit about the daily lives of Veterinarians, Teachers, Chefs, Astronauts, and Scientists! At the end of the week, take a poll to find out what each camper will "be" when they grow up.



Out of This World

Design courtesy of Bisque Imports

This neat technique gives an other-worldly look to the classic coupe plate! Try mixing colors to create an entire solar system.

MATERIALS

100 Coupe Salad
5089 Raised Star Tag-Along
5090 Large Star
5091 Medium Star
5092 Small Star
5093 Tiny Star
5094 Shooting Star
5101 Moon Face
CN013-8 Dark Straw
CN191-8 Light Ivy
CN253-8 Dark Black
CN302-8 Bright Caribbean
CN502-8 Neon Blue
CN504-8 Neon Orange
C507-8 Neon Red
FD254 Black Licorice
RAQUA144 Aqualon Assortment

SUPPLIES

Rubbing Alcohol
Small Cup
Water

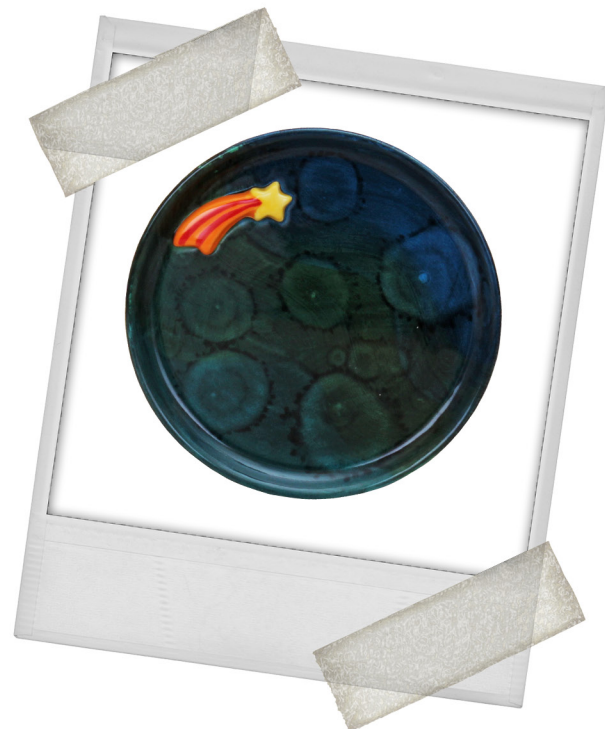

INSTRUCTIONS

1. Lightly wipe ware with a damp sponge to prepare surface for painting.
2. Alternate using 3 coats each of Neon Blue, Light Ivy, and Bright Caribbean to paint differently-shaped waves across plate. As you paint, allow colors to overlap and blend. Let dry.
3. Using a large brush, mix Dark Sapphire with water to a thin wash consistency on your pallet. Apply 1 coat of the thinned paint color to plate.
4. Immediately, using a round brush, add drops of rubbing alcohol to scattered areas of the plate to create "craters." Set aside to dry.
5. Use an assortment of colors to paint a celestial tag-along of your choice.
6. To paint the shooting star in this project, first paint the star shape with 3 coats of Dark Straw. Let



Out of This World Continued



Not into the shooting star? Try 5101 Moon Face for a night sky or 5239 Octopus for an under the sea plate!

dry, then paint stripes along the star tracer with 3 coats each of Neon Orange and Neon Red. Let dry.

7. Once dry, use Black Licorice as adhesive to securely attach tag-along to the plate.

8. Paint the backside of the plate with 2-3 coats of Dark Black. Let dry.

9. Dip in Pure Brilliance and fire to Cone 06.



Writer's Block

Design courtesy of Bisque Imports

By adding mosaic tiles to this fired tile, campers will be able to write messages on their very own mixed media dry erase board!

MATERIALS

8013 Art Tape Assortment

BIM288 Fresh Linen Mosaic Tiles 10 mm

BIM335 Sapphire Square Mosaic Tiles 12 mm

BIM341 Aquamarine Square Mosaic Tiles 12 mm

BIM364 Royal Richness Round Pebbles 12 mm

BIM394 Creamsicle Ceramic Mosaic Tiles 10 mm

BIM72946-0006 Weldbond

BISQ66 6" Tile

CN151-8 Light Blue Spruce

CN253-8 Dark Black

RAQUA144 Aqualon Assortment

SUPPLIES

Q-Tip

Ruler

Water

INSTRUCTIONS

1. Lightly wipe ware with a damp sponge to prepare surface for painting.

2. Measure out a square in the tile center, approximately 3 1/2" in size. Use Art Tape to mask the surrounding area.



3. Paint the center square with 3 coats of Light Blue Spruce. Once dry, remove painter's tape.

4. Paint the border with 3 coats of Dark Black.

5. Dip in Pure Brilliance and fire to Cone 06.

6. Use a Q-tip to apply Weldbond adhesive to small areas at a time as you adhere mosaic tiles of your choice around the frame.

7. To replicate this project, fill one corner with 4 Aquamarine Square tiles. Next, adhere 9 Creamsicle Ceramic tiles. Follow with 2 Sapphire Square tiles, 2 Royal Richness pebbles, and 9 Fresh Linen tiles. End row with 4 Aquamarine Square tiles again at the adjacent corner. Repeat pattern sequence to fill the entire frame.

8. Once completed, allow project to dry for 24 hours.



Night Night Light

Design courtesy of Bisque Imports

We love the peacock design, but try offering campers a mixture of frit colors. You'll be amazed by the wild spectrum of animals they'll create!

MATERIALS

8301 E-6000 Adhesive
CF226.74F-20 Amazon Green Opalescent Frit - Fine
CF230.72F-20 Medium Blue Opalescent Frit - Fine
CF267.72F-20 Sunflower Opalescent Frit - Fine
GBITSASST Assorted Bits
GBLOCK60-726 Apple Jade Opalescent Block
GBS3-100 3 In. Square Clear Transparent
ROMG-ASST Mardi Gras Rod Assortment
S56-96 Black Opalescent Stringers
SP450 Night Light Base
SP451 Brass Night Light Bracket
SP-8234 Glas Tac
ST340 1" Running Pliers
ST352 Pistol Grip Glass Cutter
ST356 Wheel Mosaic Cutter
ST540 Thinfire Shelf Paper

SUPPLIES

Angled Straw
Black Sharpie
Detail Brush
Detail Writer (optional)
Non-Aerosol Hairspray
Printed Template
Silver Sharpie
Water



INSTRUCTIONS

1. Using a black Sharpie, sketch the sections of the animal. If you're using a template, place the guide below the clear glass and trace it.
2. Score and cut a 1" x 1 1/2" rectangle from the Apple Jade block. Use a Wheel Mosaic Cutter to nip the corners off the two corners of one short edge to create the body. Score and cut a bit diagonally in half to use for the belly and head feathers. Nip two small black rod pieces for eyes and five small yellow rod pieces for each feather eyespot. Finally, nip a small triangle bit for the beak.
3. Arrange the glass into place on your piece, and secure using a small amount of Glas-Tac.
4. Break small pieces of Black Stringers and arrange between each tail feather. To avoid rolling, first dip the end of the Stringer in Glas-Tac glue.



Peacock Night Light Continued



Seg:	Ramp	Temp	Hold
1	300	1000	.30
2	350	1380-1395	.10
3	9999	1050	.60
4	250	800	.10

10. Use adhesive to attach fired project to the Brass Night Light Bracket, then attach bracket to the Night Light Base.

5. Fill the two bottom sections next to the body with Sunflower frit.

6. Use an angled straw to scoop a ring of Medium Blue frit around each yellow eyespot.

7. Fill in the remaining area of each tail feather with Amazon Green frit. Use a detail brush to brush off excess frit on the body and on each Stringer.

8. Once you've covered the surface with Frit, spritz the entire surface with non-aerosol hairspray. Let dry.

9. Place on a piece of Thinfire Shelf Paper and write the child's name on the paper with a Silver Sharpie. Fire to a contour fuse using the firing schedule provided:

Tip: for best results, allow the glue to completely dry before attaching the night light base.



Game it Up!

Design courtesy of Bisque Imports

This is a fun project to have fired by the last day of camp. You'll keep campers occupied with their very own game board!

MATERIALS

8013 Art Tape Assortment (optional)

BISQ66 6" Tile

CN142-8 Bright Aqua

CN211-8 Light Taupe

CN253-8 Dark Black

CN262-8 Bright Grape

CN353-8 Dark Sapphire

CN373-8 Dark Honeysuckle

CN384-8 Fruit Punch

CN504-8 Neon Orange

CN511-8 Sunflower Yellow

CN512-8 Green Apple

RAQUA144 Aqualon Assortment

SUPPLIES

Black Washable Marker

Dry-Erase Marker

Water

INSTRUCTIONS

1. Lightly wipe ware with a damp sponge to prepare surface for painting.

2. Using the template, use a black washable marker to sketch the game tile.



Template available on
Pg 70

3. Paint the lower rectangle with 3 coats of Neon Orange. If needed, use Art Tape to achieve straight edges. Let dry. Remove Art Tape.

4. Repeat step #3, using Bright Aqua, to paint the side box.

5. Above the Neon Orange box, use a detail brush and Dark Sapphire to paint "WORD:."

6. In the Bright Aqua box, use a detail brush and Dark Black to paint each letter of the alphabet.

7. Use Dark Black to paint the hanging bar.

8. With a detail brush and Light Taupe, trace over the hangman outline with small lines.

9. Paint "HANGMAN" at the top of the tile in a rainbow scheme. For this project, we used Fruit Punch, Neon Orange, Sunflower Yellow, Green Apple, Dark Sapphire, Bright Grape, and Dark Honeysuckle. Let dry.



Game it Up! Continued

To Play:

1. Player 1 thinks of a word or phrase.
2. In lower box, Player 1 uses a dry-erase marker to draw a number of dashes equivalent to the number of letters in the word.
3. Player 2 guesses letters to fill in the word.
4. For every correct guess, Player 1 writes the letter in the appropriate space. For every wrong guess, they draw one element of the hangman.
5. As game progresses, draw an X over each alphabet letter guessed.
6. For a longer game, have fun and get creative! Add hair, shoes, clothes - whatever you'd like!
7. If hangman drawing is completed first, Player 1 wins. Player 2 wins if they guess the word first.

8. Dip in Pure Brilliance and fire to Cone o6.

9. Once fired, pick a partner and you're ready to play!

Tip: Add a large # sign to the back of the tile for a tic-tac-toe board, too!



Furry Friends

Design courtesy of Bisque Imports

Don't be fooled by the name - the stemless wine glass makes a perfect bathroom cup or drink tumbler for little artists.

MATERIALS

- 2731** Stemless Wine Glass
- CN032-8** Bright Butternut
- CN244-8** Really White
- CN253-8** Dark Black
- CN312-8** Bright Ginger
- CN372-8** Bright Honeysuckle
- CN504-8** Neon Orange
- RAQUA144** Aqualon Assortment

SUPPLIES

- Black Washable Marker
- Faux Fur Yarn
- Sponge
- Water

INSTRUCTIONS

1. Lightly wipe ware with a damp sponge to prepare surface for painting.
2. Paint the outside of the cup with 3 coats of Bright Butternut. Let dry.
3. Create the look of fur using Bright Ginger and faux fur yarn! Experiment with different techniques to achieve this look: sponge the yarn, then wrap



around the cup; bunch up the yarn, then use as a sponge; or, wrap a strand of yarn around the cup, and as you keep hold of one end, sponge over the yarn onto the cup. Once completed, let dry.

4. Use a black washable marker to sketch out the animal face. For this project, we drew a cat's face.
5. Paint the face details to create your furry friend!
6. For this project, we used Bright Honeysuckle to paint the ears and tongue, Neon Orange to paint the nose and triangle stripes, Really White and Dark Black to paint the eyes, and Dark Black to paint the mouth and whiskers. Use Dark Black to trace the nose, stripes, and ears also.
7. Paint the inside of the cup with 3 coats of Neon Orange. Let dry.
8. Dip in Pure Brilliance and fire to Cone 06.



Space Traveler

Design courtesy of Bisque Imports

Far out, dude! Have templates pre-cut to make this design easy for painters of all ages.

MATERIALS

AA7010 Canvas Panel 12" x 12"

AS959 Duncan Hi-Gloss Sealer

OS431 White

OS434 Lemon Peel

OS435 Dark Yellow

OS438 Orange Peel

OS449 Bright Red

OS457 Medium Blue

OS459 Bright Blue

OS463 Medium Green

OS468 Deep Turquoise

OS476 Black

OS556 Lemon Grass

OS558 Miami Pink

OS564 Pansy

UM950 Brite Gold

UM956 Silver

RAQUA144 Aqualon Assortment

SUPPLIES

Black Sharpie

Contact Paper

Pencil

Pin

Scissors

Water

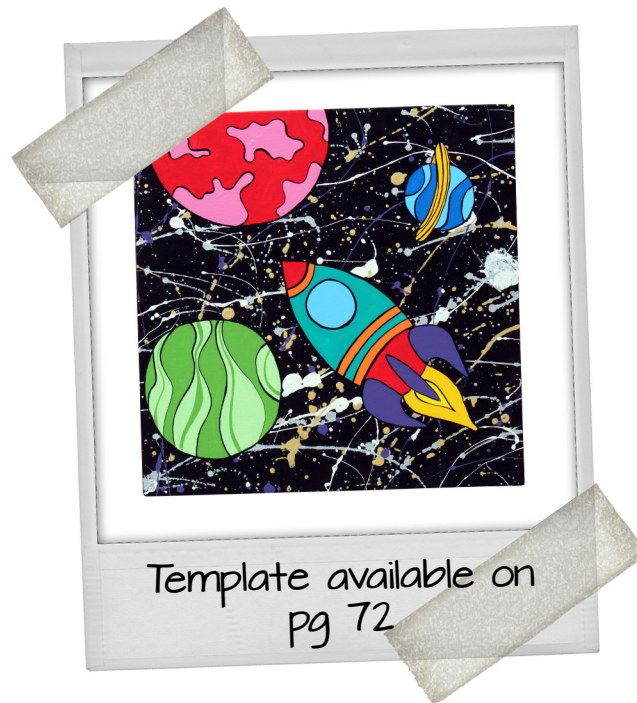

INSTRUCTIONS

1. Trace the rocket ship template onto contact paper, then cut out. Remove the sticky backing, and firmly adhere to the canvas. See template for the design used in this project.
2. Also from contact paper, cut out a variety of planet shapes and adhere to canvas.
3. Paint the canvas with Black.
4. Using a mix of acrylic paint colors, splatter paint the canvas background. To splatter paint, generously load your paintbrush with paint, stand about 1–2 inches away from canvas, and flick your wrist and arm to achieve each splatter line. Repeat as desired.
5. For this project, we splatter painted White, Pansy, Brite Gold, and Silver onto the canvas. Allow paint to dry completely.



Space Traveler Continued



Templates make it easy to create a masterpiece at any age!

6. Use a pin to gently remove contact paper shapes. Sketch the rocket ship design and each planet design onto canvas with a pencil. Paint the rocket ship and each planet with your choice of acrylic paints.
7. Paint the bottom section of the ship body with Bright Red. Use the same color to paint the tip of the ship nose.
8. Use Orange Peel to paint the stripe below the ship's nose, and the top and bottom stripe on the ship body.
9. Paint the ship window with Medium Blue.
10. Use Deep Turquoise to fill in the rest of the ship body.
11. Paint the inner flame with Lemon Peel and the outer flame with Dark Yellow.
12. Paint each fin with Pansy.

13. Alternate using Medium Green and Lemon Grass to paint each wavy section of the left corner planet. Once dry, paint a thin Medium Green wavy streak in each Lemon Grass section.

14. Use Miami Pink to paint each splatter shape on upper right planet. Fill in the rest of the planet with Bright Red.

15. Paint the ring around bottom right planet with Dark Yellow. Alternate using Medium Blue and Bright Blue to paint each wavy section on the planet.

16. Use a detail brush and Black to outline and accent the rocket ship and each planet. Let dry.

17. Once your project is completed and fully dry, cover the canvas surface with a coat of Duncan's Hi-Gloss Sealer.

Tip: to allow for ultimate creative freedom with minimal mess, have campers complete the splatter portion of the project inside a box. The cardboard liner that comes with soft drinks works well.



Yummy Fun

Design courtesy of Bisque Imports

Who says you can't play with your food? This project takes creativity to a whole new level!

MATERIALS

- 9860** 6 x 3" Tile
- 8013** Art Tape Assortment (optional)
- CN031-8** Light Butternut
- CN042-8** Bright Papaya
- CN253-8** Dark Black
- CN262-8** Bright Grape
- CN263-8** Dark Grape
- CN351-8** Light Sapphire
- CN384-8** Fruit Punch
- CN502-8** Neon Blue
- RAQUA144** Aqualon Assortment

SUPPLIES

- Assorted Pasta Noodles
- Black Washable Marker
- Contact Paper
- Scissors
- Water

INSTRUCTIONS

1. Lightly wipe ware with a damp sponge to prepare surface for painting.
2. Have a variety of dry pasta noodles available, to be used as stamps. For this project, we used angel hair, linguine, and lasagna pasta. Also try:

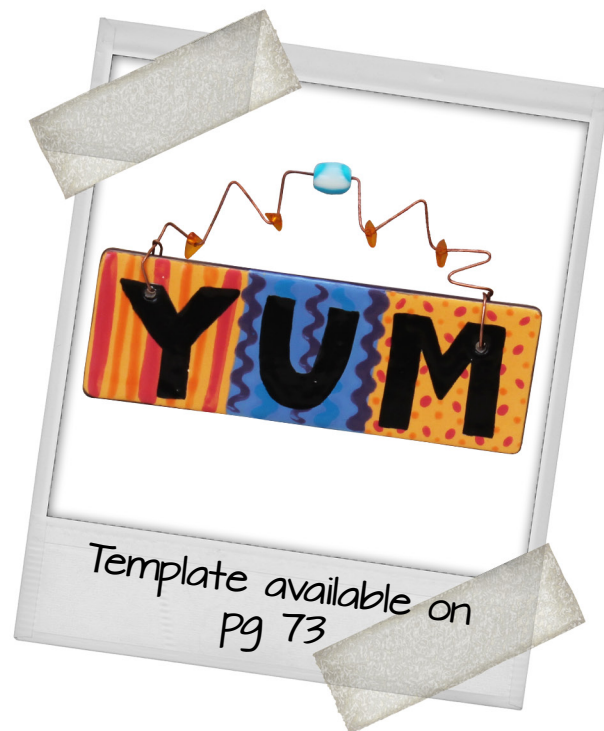

cartwheels, fettuccine, farfalle, rotini, tortellini, and other different pasta shapes.

3. Use a black washable marker to sketch "YUM" in block letters onto contact paper.
4. Cut out each letter, remove the sticky backing, then firmly adhere each letter to tile surface.
5. Use a black washable marker to separate tile into three sections.
6. Paint the outer two sections with 3 coats of Light Butternut. If desired, use Art Tape to create straight edges. Once dry, remove Art Tape.
7. Paint the middle section with 3 coats of Light Sapphire. Let dry.
8. Dip the assorted pasta noodles into the colors of your choice, then use as stamps on the tile surface to create your own background in each section. Let dry.



Yummy Fun Continued



Tip: Drill holes and add beads to make it a plaque, or attach adhesive strips to hang from a wall!

9. Remove each letter template. With 2-3 coats of Dark Black, fill in each letter.

10. Paint the tile edges and backside with 3 coats of Dark Grape. Let dry.

11. Dip in Pure Brilliance and fire to Cone 06.



Sweet as Pie

Design courtesy of Bisque Imports

Our compliments to the chef, and the artist! This cute project has a built in game for added fun.

MATERIALS

261 Pizza Slice Dish
CN232-8 Bright Briarwood
CN244-8 Really White
CN253-8 Dark Black
CN282-8 Bright Brown
CN311-8 Light Ginger
CN384-8 Fruit Punch
CN512-8 Green Apple
RAQUA144 Aqualon Assortment

Visit the template section view the full dice game!

SUPPLIES

Black Washable Marker
Dice
Sponge
Water

INSTRUCTIONS

1. Play the dice game to determine the eyes, mouth, and toppings of your pie face. See the template provided for the unique pie face used in this project.
2. Paint the plate surface with 3 coats of Light Ginger. Let dry.
3. Lightly sponge the pie crust with Bright Brown.
4. Use the same color and sponge to sponge a Bright Brown crosshatch pattern across the plate surface.



Allow paint to dry completely.

5. Using a black washable marker, sketch out each part of your pie face onto the plate surface. See the template provided for the unique pie face used in this project.
6. For this project, we first used 3-4 coats of Really White to paint the eyes.
7. Paint the tongue with 3 coats of Really Red.
8. With 2-3 coats of Dark Black, fill in the center of the eyes. Use the same color and a detail brush to outline and accent the eyes and mouth.
9. Fill in the cherries with 3 coats of Fruit Punch. Use 3 coats of Green Apple to fill in the leaf, then Dark Black to outline the stem, cherries, and leaf.
10. Using a detail brush and 2-3 coats of Bright Briarwood, paint the chocolate drizzle line. Let dry.
11. Dip in Pure Brilliance and fire to Cone 06.



Bubble Experiment

Design courtesy of Bisque Imports

Little scientists will love experimenting with color to create a bubble effect! You can add glass paint for a fun design component, too.

MATERIALS

- CF100C-20** Clear Transparent Frit - Coarse
- CF123F-20** Medium Green Transparent Frit - Fine
- CF523F-20** Teal Transparent Frit - Fine
- CF528.4F-20** Steel Transparent Frit - Fine
- CF533.1F-20** Sky Blue Transparent Frit - Fine
- CF533.3F-20** Deep Aqua Transparent Frit - Fine
- GBS6-100** 6 In. Square Clear Transparent
- GP100** Crystal Clear Transparent Pebbles
- ST540** Thinfire Shelf Paper

SUPPLIES

- Detail Writer (optional)
- Non-Aerosol Hairspray
- Plastic Spoon
- Silver Sharpie

INSTRUCTIONS

1. Use a spoon to scoop an even spread of Teal Transparent fine frit over 6" square base.
2. Use a spoon to lightly spread Steel Transparent fine frit diagonally across one corner of project base.
3. Repeat step #2 using Deep Aqua, Sky Blue Transparent and Medium Green Transparent fine frit to fill remainder of project. As you add colors, mix the colored frit with its bordering color(s) to create a blended effect across project.

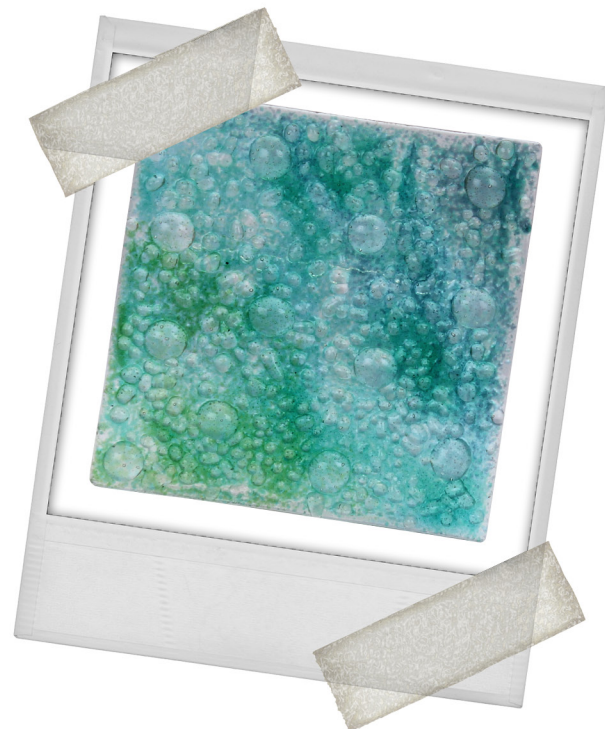

4. Sprinkle a light layer of Teal Transparent fine frit again over entire project.
5. Add Crystal Clear pebbles in scattered spots on project.
6. Add a light spread of Clear Transparent coarse frit over the scattered areas between pebbles.
7. Spritz the project with hairspray, or apply a small amount using a detail writer filled with hairspray. Let dry.
8. Place on a piece of Thinfire Shelf Paper and write the child's name on the paper with a Silver Sharpie. Fire to a contour fuse using the firing schedule provided:

Seg:	Ramp	Temp	Hold
1	300	1000	.30
2	350	1380-1395	.10
3	9999	1050	.60
4	250	800	.10



Mad Scientist Lab Coat

Design courtesy of Bisque Imports

Future scientists will love the chance to create their very own wacky lab coat!

MATERIALS

D22676 Ultimate Tie-Dye Kit

SUPPLIES

Adult Size T-Shirt
Gallon Size Ziplock Bags
Latex Gloves
Permanent Marker
Plastic Tablecloth
Rubber Bands
Scissors
Trash Bags

**TIP: Always wear gloves
when handling dye to
keep hands clean!**

INSTRUCTIONS

1. Use a permanent marker to write each camper's name on their shirt tag and gallon-sized Ziplock bag.
2. Set up workspace. Cover any counter or table space with large trash bags or a plastic tablecloth. If you have a large sink available, use this space to dye each t-shirt.
3. Fill each dye bottle with water up to the line, then thoroughly shake to mix color.

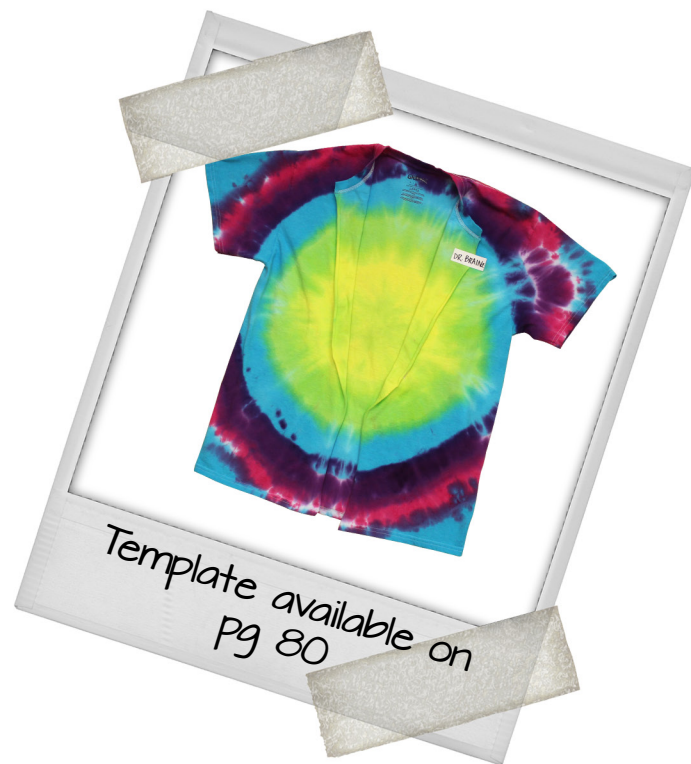

4. Use multiple rubber bands to band t-shirt according to the desired technique design. See template for a guide to each technique.
5. Apply dye directly to fabric, ensuring the dye is penetrating all layers. Be careful not to oversaturate the shirt, as colors will begin to muddle together.
6. Once dyed, place damp t-shirt into the gallon-sized Ziplock bag and allow t-shirt to set for at least 6-8 hours. Prolong time to achieve greater color intensity.
7. Follow the kit instructions to rinse, wash, and dry the t-shirt.
8. Once finished, use scissors to cut down the front of the t-shirt to create your own tie-dye lab coat!



Material List

BISQUE

- 100** Coupe Salad
- 261** Pizza Slice Dish
- 1843** Mini Rectangle Plaque
- 2731** Stemless Wine Glass
- 5094** Shooting Star
- 5089** Raised Star Tag-Along
- 5090** Large Star
- 5091** Medium Star
- 5092** Small Star
- 5093** Tiny Star
- 5101** Moon Face
- 9860** 6 x 3" Tile

PAINT

- CN013-8** Dark Straw
- CN031-8** Light Butternut
- CN032-8** Bright Butternut
- CN042-8** Bright Papaya
- CN142-8** Bright Aqua
- CN151-8** Light Blue Spruce
- CN191-8** Light Ivy
- CN211-8** Light Taupe
- CN232-8** Bright Briarwood
- CN244-8** Really White
- CN253-8** Dark Black
- CN262-8** Bright Grape
- CN263-8** Dark Grape
- CN282-8** Bright Brown
- CN302-8** Bright Caribbean
- CN311-8** Light Ginger
- CN312-8** Bright Ginger
- CN351-8** Light Sapphire
- CN353-8** Dark Sapphire
- CN372-8** Bright Honeysuckle
- CN373-8** Dark Honeysuckle
- CN384-8** Fruit Punch
- CN502-8** Neon Blue
- CN504-8** Neon Orange
- C507-8** Neon Red

- CN511-8** Sunflower Yellow
- CN512-8** Green Apple
- FD254** Black Licorice
- OS431** White
- OS434** Lemon Peel
- OS435** Dark Yellow
- OS438** Orange Peel
- OS449** Bright Red
- OS457** Medium Blue
- OS459** Bright Blue
- OS463** Medium Green
- OS468** Deep Turquoise
- OS476** Black
- OS556** Lemon Grass
- OS558** Miami Pink
- OS564** Pansy
- UM950** Brite Gold
- UM956** Silver

CRAFT & SUPPLIES

- 8013** Art Tape Assortment
- 8301** E-6000 Adhesive
- AA7010** Canvas Panel 12" x 12"
- AS959** Duncan Hi-Gloss Sealer
- RAQUA144** Aqualon Assortment
- SP450** Night Light Base
- SP451** Brass Night Light Bracket
- SP-8234** Glas Tac
- ST340** 1" Running Pliers
- ST352** Pistol Grip Glass Cutter
- ST356** Wheel Mosaic Cutter
- ST540** Thinfire Shelf Paper

WARM GLASS

- CF100C-20** Clear Transparent Frit - Coarse
- CF123F-20** Medium Green Transparent Frit - Fine
- CF226.74F-20** Amazon Green Opalescent Frit - Fine

- CF230.72F-20** Medium Blue Opalescent Frit - Fine
- CF267.72F-20** Sunflower Opalescent Frit - Fine
- CF523F-20** Teal Transparent Frit - Fine
- CF528.4F-20** Steel Transparent Frit - Fine
- CF533.1F-20** Sky Blue Transparent Frit - Fine
- CF533.3F-20** Deep Aqua Transparent Frit - Fine
- GBITSASST** Assorted Bits
- GBLOCK60-726** Apple Jade Opalescent Block
- GBS6-100** 6 In. Square Clear Transparent
- GBS3-100** 3 In. Square Clear Transparent
- GP100** Crystal Clear Transparent Pebbles
- ROMG-ASST** Mardi Gras Rod Assortment
- S56-96** Black Opalescent Stringers

MOSAICS

- BIM288** Fresh Linen Mosaic Tiles 10 mm
- BIM335** Sapphire Square Mosaic Tiles 12 mm
- BIM341** Aquamarine Square Mosaic Tiles 12 mm
- BIM364** Royal Richness Round Pebbles 12 mm
- BIM394** Creamsicle Ceramic Mosaic Tiles 10 mm
- BIM72946-0006** Weldbond



Art Around the World



Mondrian



Klimt



Seurat



Picasso

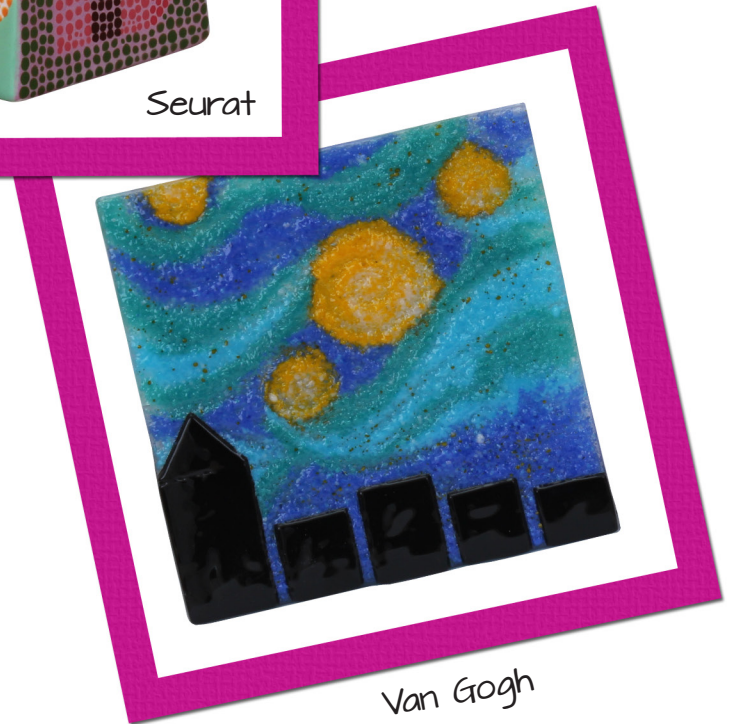

Van Gogh



Overview

SCHEDULE

Monday

9:00-9:30 : Drop off, decorate name tags & gift bags

9:15-9:30 : Introductions

9:30-10:45 : Perfect Pointillism (Fire by Friday)

10:45-11:15 : Clean up, snack

11:15-12:00 : Oh, Starry Night (Fire by Friday)

Tuesday

9:00-9:15 : Drop off

9:15-10:15 : Seeing Double (Fire by Friday)

10:15-10:45 : Clean up, snack

10:45-11:45 : Krazy Kandinsky (Fire by Friday)

11:45-12:00 : Mod Mosaic: Decoupage photo onto base and let dry

Wednesday

9:00-9:15 : Drop off

9:15-10:00 : Mod Mosaic: Decorate with glass photo tiles and mosaic tiles

10:00-10:30 : Clean up, Snack

10:30-11:00 : Picasso Shape Art Activity with construction paper

11:00-12:00 : Creativi-Tree

Thursday

9:00-9:15 : Drop off

9:15-10:00 : Mirror, Mirror: Paint self-portrait half

10:00-10:30 : Clean up, snack

10:30-11:15 : Mirror, Mirror: Paint partner half

11:15-11:30 : Grout mosaics

11:30-12:00 : Clean mosaic tiles off

Friday

9:00-9:15 : Drop off

9:15-9:45 : Mod Mosaic : Paint sides, back, and grout

9:45-10:15 : Thank you cards for parents

10:15-10:45 : Clean up, snack

10:45-11:30 : Creativi-Tree: Complete canvas with craft supplies

11:45-12:00 : Wrap up, package up projects

Snack Ideas:

1. Decorate Graham Cracker "canvases" with icing and fruit.
2. Make fruit "faces" with apples, grapes, pineapple, and bananas

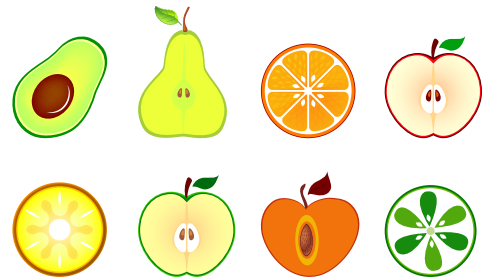

- Tips for stress and mess free grouting with campers**
1. Mix your grout to a thin peanut butter consistency in a large mixing bowl.
 2. Have the table and work area prepared with trash bags or a disposable table cloth.
 3. Walk around the table and dispense a small dollop of grout onto each camper's project.
 4. Instruct the campers to quickly smooth the grout into the areas between tiles. The final result should fill in all the spaces, while the tiles are all still visible under a thin cloudy layer. Don't forget to wipe the sides of the mosaic with a thin layer of grout, too!
 5. Allow to dry for a few minutes (the next step is easier if the grout is still a little wet!)
 6. Give each camper a damp sponge so they can wipe the grout off the top of the tiles. Since the grout isn't dry, don't focus on removing the cloudiness but the grit of the grout at this step.
 7. Set projects aside and allow to completely dry. Wrap up tablecloth and throw away.
 - 8 Optional last step: spritz a paper towel with glass cleaner. Polish each tile to remove any cloudiness.



Krazy Kandinsky

Design courtesy of Bisque Imports

Dive into the work of a famous artist in a kid friendly way! Parents and kids alike will love the final results.

MATERIALS

- 104** Metropolitan Coupe Salad
- 9591** Paint Dotters
- CN042-8** Bright Papaya
- CN123-8** Dark Nautical
- CN181-8** Light Kiwi
- CN253-8** Dark Black
- CN262-8** Bright Grape
- CN263-8** Dark Grape
- CN292-8** Bright Purple
- CN302-8** Bright Caribbean
- CN351-8** Light Sapphire
- CN352-8** Bright Sapphire
- CN353-8** Dark Sapphire
- CN372-8** Bright Honeysuckle
- CN373-8** Dark Honeysuckle
- CN503-8** Neon Chartreuse
- RAQUA144** Aqualon Assortment

TIP: Try creating your own custom circle stamps by cutting sponges into different circle shapes!

SUPPLIES

- Black Washable Marker
- Ruler
- Scissors (optional)
- Sponges (optional)
- Water



INSTRUCTIONS

1. Lightly wipe ware with a damp sponge to prepare surface for painting.
2. Use a ruler and a black washable marker to divide the plate into nine equal square sections.
3. Use an assortment of lighter shade paint colors, 3 coats each, to fill in each square section. For this project, we used Bright Papaya, Light Kiwi, Bright Purple, Light Sapphire, Bright Honeysuckle, and Neon Chartreuse. Let dry.
4. In each section, use a black washable marker to lightly sketch a large circle. Fill in each circle with a color slightly darker than its background color.
5. Alternate using Paint Dotters and handdrawn circles as outlines to create concentric circles within each large circle. Use each Paint Dotter by dipping it into the paint, onto a separate surface to remove excess, then onto project. Paint or sponge 3 coats of



Krazy Kandinsky Continued

Did you know? Kandinsky was famous for studying the relationship between art, music, and shapes. Try leading kids through the lesson by playing a piece of a song and having them paint each circle based off of how it makes them feel.

color to fill in each circle. Let dry.

6. When painting each circle, use lighter colors before using darker colors. For each concentric circle in this project, we used Dark Nautical, Light Kiwi, Dark Black, Bright Grape, Dark Grape, Bright Purple, Bright Caribbean, Bright Sapphire, Dark Sapphire, and Dark Honeysuckle.

6. Paint the backside of plate with 3 coats of Dark Sapphire, or another color of your choice. Let dry.

7. Dip in Pure Brilliance and fire to Cone 06.



Oh, Starry Night

Design courtesy of Bisque Imports

Frit makes it easy to mimic the beautiful sweeping colors of the original in this great project.

MATERIALS

- CF200F-20** White Opalescent Frit - Fine
- CF223.72F-20** Turquoise Green Opalescent Frit - Fine
- CF223-74-F-20** Peacock Green Opal Frit - Fine
- CF230.72F-20** Medium Blue Opalescent Frit - Fine
- CF267.72F-20** Sunflower Opalescent Frit - Fine
- GBLOCK1009** Black Opalescent Block
- GBS6-100** 6 In. Square Clear Transparent
- SP-8234** Glas Tac
- ST340** 1" Running Pliers
- ST352** Pistol Grip Glass Cutter
- ST540** Thinfire Shelf Paper

SUPPLIES

- Black Sharpie
- Detail Brush
- Detail Writer (optional)
- Non-Aerosol Hairspray
- Printed Template
- Ruler
- Silver Sharpie
- Spoon

INSTRUCTIONS

1. Place the 6" clear square over the printed template image. Trace the design with a black Sharpie.

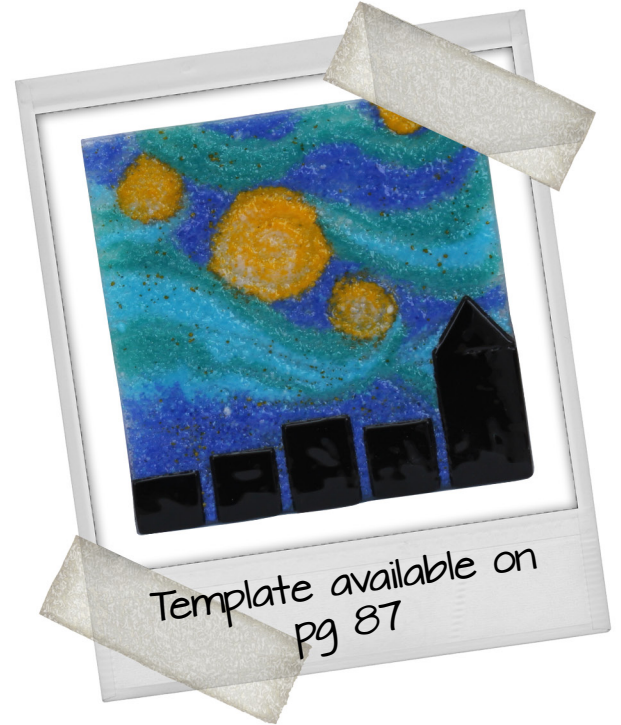

2. Place the Black Opalescent block on a cutting surface. Score and cut a 1" x 2" rectangle, a triangle with a 1" base, and 4 additional, smaller rectangle and square shapes.
3. Position each Black Opal piece along bottom edge of glass. Secure using a small amount of Glas Tac.
4. In a cup, use a spoon to scoop and mix a small amount of White and Sunflower frit. Use spoon and frit mixture to fill each inner swirl circle.
5. Use a spoon to create a ring around each filled circle with Sunflower frit.
6. Alternate using Turquoise Green and Peacock Green frit to fill in each swirl line area.
7. Fill in the remaining background areas with Medium Blue frit.

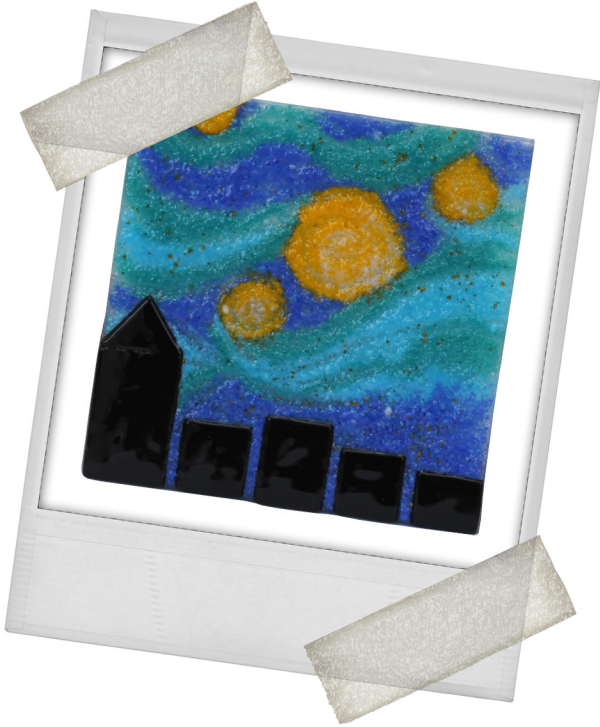

Oh, Starry Night Continued

Seg:	Ramp	Temp	Hold
1	300	1000	.30
2	350	1380-1395	.10
3	9999	1050	.60
4	250	800	.10

8. With the handle of a detail brush, gently marbleize the colored frit in the direction of each swirl.

9. Sprinkle a small amount of White and Sunflower frit in scattered areas across background. Use the paintbrush to brush off any excess frit left on the Black Opal surfaces.

10. Spritz the project with hairspray, or apply a small amount using a detail writer filled with hairspray. Let dry.

11. Place on a piece of Thinfire Shelf Paper and write the child's name on the paper with a Silver Sharpie. Fire to a contour fuse using the firing schedule provided:

Did you know? Van Gogh painted Starry Night during the day. The painting was his interpretation of the view from his ground floor window at a hospital in France.



Seeing Double



Design courtesy of Bisque Imports

Incorporate a lesson on colors as you paint to create a full art learning experience!

MATERIALS

- 949** 3.5 In. Square Tile (4)
- CN032-8** Bright Butternut
- CN042-8** Bright Papaya
- CN121-8** Light Nautical
- CN253-8** Dark Black
- CN262-8** Bright Grape
- CN291-8** Light Purple
- CN351-8** Light Sapphire
- CN353** Dark Sapphire
- CN373-8** Dark Honeysuckle
- CN384-8** Fruit Punch
- CN512-8** Green Apple
- RAQUA144** Aqualon Assortment
- TCW2031** Butterfly Bits - 4" X 4" Template

SUPPLIES

- Black Washable Marker
- Water

INSTRUCTIONS

1. Lightly wipe each tile with a damp sponge to prepare surface for painting.
2. Lay stencil on each tile. Trace stencil design with a Black Washable Marker.

3. On the first tile, use a combination of Concepts colors to fill in the design areas and background with 3 coats of paint. Let dry.
4. On the remaining tiles, repeat step #3 using a different color scheme for each tile.
5. Use 2-3 coats of Dark Black to paint the edges and backside of each tile. Let dry.
6. Once completed, dip each tile in Pure Brilliance and fire to Cone 06.

Try using some of these other TCW stencils as well:

TCW389 Fancy Feather
TCW185 Birds



Mod Mosaic

Design courtesy of Bisque Imports

Mosaics make the perfect medium for exploring Mondrian's mod lines and colors.

MATERIALS

- 4 x 6 Mosaic Plaque (COMING SOON)
- BIM287** Espresso Mosaic Tiles 10 mm
- BIM288** Fresh Linen Mosaic Tiles 10 mm
- BIM337** Topaz Square Mosaic Tiles 12 mm
- BIM340** Cobalt Square Mosaic Tiles 12 mm
- BIM507** Rouge Crystal Glass Mosaic Tiles 10 mm
- BIM70212-0003** White Grout
- BIM72064** Clear Cathedral Nibbles & Bits
- BIM72946-0006** Weldbond
- D15481** Aleene's Glass & Bead Glue
- D31210** Aleene's Matte Decoupage
- RAA-5107** Primary Yellow
- RAA-5111** Naphtholene Carmine
- RAA-5114** Dark Ultramarine
- RAA-5120** Mars Black
- RAQUA144** Aqualon Assortment
- ST356** Wheel Mosaic Nipper

SUPPLIES

- Assorted Photos
- Glue Stick
- Latex Gloves
- Paper Towels
- Pencil
- Plastic Spoon (to mix grout)
- Scissors
- Self-Laminating Sheets (optional)

Money saving tip - order grout in the 1 pound size to save up to \$1.00 per camper! (covers 4-6 projects depending on size)



Small Disposable Bowl (for grout mix)
Water

INSTRUCTIONS

1. Cut out and position photo onto corner of plaque. Adhere with a glue stick.

TIP: If using an inkjet printer to print photos, prevent ink bleeding by sealing each photo with a self-laminating sheet before adhering to tile.

2. Using a paintbrush, apply a coat of decoupage over the tile to seal photo to surface. Allow decoupage to dry completely.

3. Use Aleene's Glass & Bead glue as adhesive to adhere Clear Cathedral bits over the photo. Leave a small space in between each piece for grout. If needed, use a Wheel Mosaic Nipper to nip pieces to the desired size.

5. Using Weldbond as adhesive, adhere Fresh Linen **44**

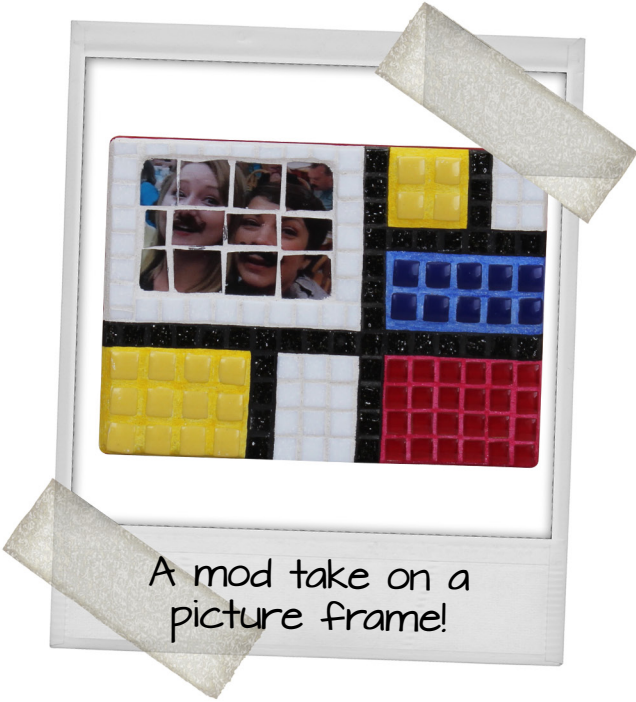

A mod take on a picture frame!

Mod Mosaic Continued

thinned paint wash to paint the grout in the section with Rouge Crystal Glass tiles.

12. Repeat step #11 to fill in the Topaz Square tiled section(s) with Primary Yellow, the Cobalt Square tiled section(s) with Dark Ultramarine, and each Espresso tiled line with Mars Black. Let dry.

The Dutch painter Piet Mondrian (1872-1944) created a geometrical abstract style known as neoplasticism, which had widespread influence on modern painting, architecture, and design.

tiles around the border of the photo.

6. Use a pencil to separate the remaining area of plaque into boxed sections of various sizes.

7. Along each pencil line, adhere Espresso tiles to create borderlines.

8. Alternate adhering Fresh Linen tiles, Topaz Square tiles, Cobalt Square tiles, and Rouge Crystal Glass tiles to fill in each section.

9. Let your mosaic project dry for 24 hours. Then, follow the grouting instructions found on page 37 to finish using White Grout.

10. Allow grout to dry to the touch. Then paint each side of the plaque with Naphtholene Carmine. Let dry.

11. On your palette, mix a very small amount of Naphtholene Carmine with water to achieve a thin wash consistency. Use a paintbrush and the



Perfect Pointillism

Design courtesy of Bisque Imports

Pointillism is a great technique for children, because it relies on filling sketched outlines with small dots of color. Let campers pick their favorite things to paint.

MATERIALS

- 1862 Square Vessel
- CN012-8 Bright Straw
- CN032-8 Bright Butternut
- CN141-8 Light Aqua
- CN182-8 Bright Kiwi
- CN232-8 Bright Briarwood
- CN244-8 Really White
- CN253-8 Dark Black
- CN271-8 Light Jade
- CN291-8 Light Purple
- CN292-8 Bright Purple
- CN311-8 Light Ginger
- CN353-8 Dark Sapphire
- CN372-8 Bright Honeysuckle
- CN384-8 Fruit Punch
- CN502-8 Neon Blue
- CN504-8 Neon Orange
- CN510-8 Earthen Moss
- RAQUA144 Aqualon Assortment

SUPPLIES

- Black Washable Marker
- Contact Paper
- Q-Tip (optional)
- Scissors



- Toothpick (optional)
- Water

INSTRUCTIONS

1. Lightly wipe ware with a damp sponge to prepare surface for painting.
2. Paint one side of the Square Vessel with 3 coats of Bright Straw.
3. Paint the opposite side with 3 coats of Light Purple.
4. On a 3" x 4" piece of contact paper, use a black sharpie to draw the shape outline of one favorite thing. On another piece of contact paper, draw the shape outline of a second favorite thing. In this project, we drew an ice cream cone and a fox.
5. Cut out each favorite thing shape. Remove the protective backing, then firmly adhere each shape to one of two unpainted sides.



Perfect Pointillism Cont.

6. Paint one unpainted side with 3 coats of Light Aqua. Paint the other unpainted side with 3 coats of Light Jade. Once dry, gently remove contact paper shape.

7. In each favorite thing shape, use a black washable marker to draw the shape details.

8. Using either a Q-tip, a toothpick, or the tip of a detail brush, fill in each shape with small colored dots.

9. To paint the ice cream cone, we used Fruit Punch and Bright Honeysuckle to fill in the syrup topping, Bright Briarwood to fill in the ice cream color, Earthen Moss to trace the checkerboard cone lines, and Bright Butternut to fill in the rest of the cone.

10. To paint the fox, we used Light Ginger to paint the tail end, chest, and cheeks; Bright Honeysuckle to paint the ears; Neon Orange to paint the body, tail, and head; and Dark Black to paint the nose and eyes.

11. On one fully painted side, use a thin black Sharpie to sketch out one favorite place. On the other fully painted side, sketch out a second favorite place. For this project, we drew a house and a beach scene.

12. To paint the house scene, we used Neon Blue to paint the clouds, Earthen Moss and Bright Briarwood to paint the roof, Bright Honeysuckle and Fruit Punch to paint the house sides, Bright Briarwood to paint the door, Dark Black and Bright Butternut to paint the windows, and Bright Kiwi to paint the grass.

13. To paint the beach scene, we used Neon Orange to paint the sun, Really White to paint the umbrella stand, Fruit Punch and Bright Purple to paint the umbrella, Earthen Moss to paint the sand, and Neon Blue and Dark Sapphire to paint the water.

14. Paint the inside with 3 coats of Dark Sapphire. Let dry.

15. Dip in Pure Brilliance and fire to Cone 06.

Did you know: Artist Georges Seurat was the developer of a very scientific way of painting known as pointillism. He used tiny dots of pure color, side by side to build form in his paintings. These tiny dots of paint, when side by side, give the viewer's eye a chance to blend the color optically, rather than having the colors readily blended on the canvas. This was also known as divisionism.



Mirror, Mirror

Design courtesy of Bisque Imports

This Picasso portrait has a fun twist - campers will paint their self portrait on one half, and then switch canvases with a partner who will paint what they see! The result? A totally cool & abstract self portrait! No peeking! It's fun to reveal your work to your partner once the painting is totally finished.

MATERIALS

- AA7010** Canvas Panel 12" x 12"
- AS959** Duncan Hi-Gloss Sealer
- OS436** Gold
- OS438** Orange Peel
- OS449** Bright Red
- OS457** Medium Blue
- OS459** Bright Blue
- OS463** Medium Green
- OS469** Light Turquoise
- OS473** Black Brown
- OS476** Black
- OS558** Miami Pink
- OS564** Pansy
- RAQUA144** Aqualon Assortment

SUPPLIES

Pencil
Water

INSTRUCTIONS

1. In the center of canvas, use a pencil to sketch a head shape, neck, and shoulder line.



2. On one half of the face, sketch a profile of your self-portrait. Draw the mouth, nose, eye, ear, hair, and any accessories.
3. Using a variety of acrylic paint colors, paint the self-portrait half of the face. Mimic Picasso's style of painting by using fun and funky colors!
4. For this project, we used Gold to paint the face; Orange peel for the neck; Black Brown and Bright Blue for the hair; Light Turquoise and Medium Green for the ear; Bright Blue and Medium Green for the shirt; Medium Green for the mouth; Light Turquoise for the nose and eyebrow; and Orange Peel, Medium Green, Bright Blue, and Medium Blue to paint the eye.
5. On the painted half of the canvas, fill in the background with Miami Pink. Accent with polka dots in a contrasting color. Let dry.
6. Now switch with your partner across the table! From here on, all steps will be completed on the



Mirror, Mirror Continued

partner's canvas. On the unpainted half of the canvas, sketch a partner's frontal portrait with a pencil.

7. Again, use a variety of colors to fill in your partner's portrait.

8. For this project, we used Medium Blue to paint the face; Light Turquoise for the neck; Bright Red and Pansy for the hair; Gold for the ear; Miami Pink for the necklace and mouth; Bright Red for the eyebrow; and Gold, Miami Pink, Pansy, and Light Turquoise for the eye.

9. Fill in the remaining half of background with Medium Green. Accent as desired. Let dry.

10. Use a detail brush and Black to outline and accent the entire project.

11. Once your project is completed and fully dry, cover the canvas surface with a coat of Duncan's Hi-Gloss Sealer.



Creativi- Tree

Design courtesy of Bisque Imports

This spin on Klimt's masterpiece will get your campers swirling with creative ideas!

MATERIALS

- 8013** Art Tape Assortment
- 8301** E-6000 Adhesive
- AA7010** Canvas Panel 12" x 12"
- AS959** Duncan Hi-Gloss Sealer
- BVP-2004** Etcetera Button Value Pack
- BW-S03** Gold Artistic Wire 22 Gauge
- OS435** Dark Yellow
- OS438** Orange Peel
- OS439** Hot Orange
- OS449** Bright Red
- OS463** Medium Green
- OS472** Walnut
- RAQUA144** Aqualon Assortment

SUPPLIES

- Pencil
- Plastic Wrap
- Q-Tip (to apply adhesive)
- Small Cup
- Water

INSTRUCTIONS

1. Paint the canvas background with splotches of bright acrylic colors. For this project, we used Dark Yellow, Orange Peel, and Hot Orange.



2. In a small cup, create a paint wash mix consisting of 3 parts water to 1 part Bright Red.

3. Brush color wash onto canvas surface in small areas at a time. After each area is painted, immediately press a bundle of wrinkled plastic wrap firmly onto canvas surface, then remove from surface to reveal texture. Let dry.

4. Once dry, lightly sketch a tree design onto the canvas with a pencil.

5. Paint the trunk of the tree with Walnut. Paint the trunk in fluid motions by drawing the sides swaying as opposed to drawing straight lines. Extend branches from center and paint swirls at each branch tip.

6. Along bottom edge of canvas, use Medium Green to paint the ground. Let dry.

7. Once your project is completed and fully dry, cover the canvas surface with a coat of Duncan's Hi-50



Creativi-Tree Continued

Tip : Use Art Tape to hold the wire curves and swirls in place as the glue dries. Swirl wire evenly around a pen or a marker for uniform shapes!

Gloss Sealer. Let dry.

8. Form long curves and spirals with Gold Artistic Wire, to flow with the direction of the tree trunk and branches. Use E6000 to adhere each wire swirl to canvas surface surface.
9. Use E6000 to adhere your choice of buttons along scattered areas of the ground, tree trunk, and along scattered branch swirls. Let dry.



Material List

BISQUE

- 104** Metropolitan Coupe Salad
- 949** 3.5 In. Square Tile (4)
- 1862** Square Vessel

PAINT

- CN012-8** Bright Straw
- CN032-8** Bright Butternut
- CN042-8** Bright Papaya
- CN123-8** Dark Nautical
- CN141-8** Light Aqua
- CN181-8** Light Kiwi
- CN182-8** Bright Kiwi
- CN232-8** Bright Briarwood
- CN244-8** Really White
- CN253-8** Dark Black
- CN262-8** Bright Grape
- CN263-8** Dark Grape
- CN271-8** Light Jade
- CN291-8** Light Purple
- CN292-8** Bright Purple
- CN302-8** Bright Caribbean
- CN311-8** Light Ginger
- CN351-8** Light Sapphire
- CN352-8** Bright Sapphire
- CN353-8** Dark Sapphire
- CN372-8** Bright Honeysuckle
- CN373-8** Dark Honeysuckle
- CN384-8** Fruit Punch
- CN502-8** Neon Blue
- CN503-8** Neon Chartreuse
- CN504-8** Neon Orange
- CN510-8** Earthen Moss
- CN512-8** Green Apple
- OS435** Dark Yellow
- OS436** Gold
- OS438** Orange Peel
- OS439** Hot Orange
- OS449** Bright Red
- OS457** Medium Blue

- OS459** Bright Blue
- OS463** Medium Green
- OS469** Light Turquoise
- OS472** Walnut
- OS473** Black Brown
- OS476** Black
- OS558** Miami Pink
- OS564** Pansy
- RAA-5107** Primary Yellow
- RAA-5111** Naphtholene Carmine
- RAA-5114** Dark Ultramarine
- RAA-5120** Mars Black

CRAFT & SUPPLIES

- 8013** Art Tape Assortment
- 8301** E-6000 Adhesive
- 9591** Paint Dotters
- AA7010** Canvas Panel 12" x 12"
- AS959** Duncan Hi-Gloss Sealer
- BVP-2004** Etcetera Button Value Pack
- BW-S03** Gold Artistic Wire 22 Gauge
- D15481** Aleene's Glass & Bead Glue
- D31210** Aleene's Matte Decoupage
- RAQUA144** Aqualon Assortment
- SP-8234** Glas Tac
- ST340** 1" Running Pliers
- ST352** Pistol Grip Glass Cutter
- ST356** Wheel Mosaic Nipper
- ST540** Thinfire Shelf Paper
- TCW2031** Butterfly Bits - 4" X 4" Template

WARM GLASS

- CF200F-20** White Opalescent Frit - Fine
- CF223.72F-20** Turquoise Green Opalescent Frit - Fine
- CF223-74-F-20** Peacock Green Opal Frit - Fine
- CF230.72F-20** Medium Blue Opalescent

Frit - Fine

- CF267.72F-20** Sunflower Opalescent Frit - Fine
- GBLOCK1009** Black Opalescent Block
- GBS6-100** 6 In. Square Clear Transparent

MOSAICS

- 4 x 6 Mosaic Plaque (COMING SOON)
- BIM287** Espresso Mosaic Tiles 10 mm
- BIM288** Fresh Linen Mosaic Tiles 10 mm
- BIM337** Topaz Square Mosaic Tiles 12 mm
- BIM340** Cobalt Square Mosaic Tiles 12 mm
- BIM507** Rouge Crystal Glass Mosaic Tiles 10 mm
- BIM70212-0003** White Grout
- BIM72064** Clear Cathedral Nibbles & Bits
- BIM72946-0006** Weldbond



Just for Tweens

Friends Forever 

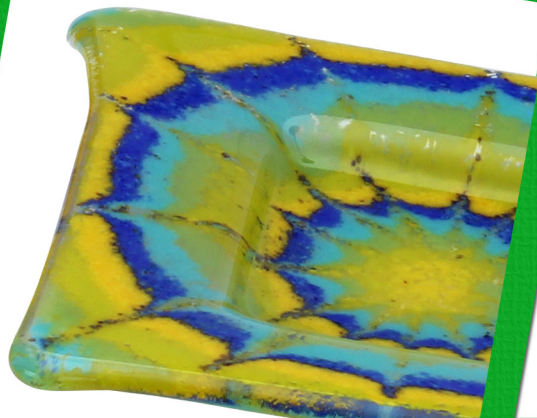

Overview

SCHEDULE

Monday

- 9:00-9:30 : Drop off, decorate name tags & gift bags
- 9:15-9:30 : Introductions, name your favorite song
- 9:30-10:15 : Geometric Magic: Assemble glass border design onto 8" Sq. Tile (Fire by Wednesday)
- 10:15-10:45 : Clean up, snack
- 10:45-12:00 : Totally Tie-Dye (Fire by Wednesday to paint picture frame)

Tuesday

- 9:00-9 :15 : Drop off
- 9:15-10:15 : BFF mug (Fire by Friday)
- 10:15-10:45 : Clean up and snack
- 10:45-11:15 : Glamour Shots: Decoupage photos and let dry
- 11:15-12:00 : Totally Charming

Wednesday

- 9:00-9:15 : Drop off
- 9:15-10:00 : Monogram Me
- 10:00-10:15 : Clean up
- 10:15-10:30 : Snack : Edible Popcorn painting - <http://www.livinglocurto.com/2010/02/indoor-fun-with-edible-paint/>
- 10:30-11:00 : Doodlez Color Wheel
- 11:00-12:00 : Glamour Shots: Assemble photo tiles and mosaic pieces onto base

Thursday

- 9:00-9:15 : Drop off
- 9:15-10:15 : Geometric Magic: Paint frame and assemble with glass border
- 10:15-10:45 : Clean up, snack
- 10:45-11:30 : Grout mosaic and clean tiles off
- 11:30-12:00 : Paint edges, back, and grout with acrylics and sparklers

Friday

- 9:00-9:15 : Drop off
- 9:15-10:15 : Play Selfie Expression dice game and sketch design onto canvas
- 10:15-10:30 : Clean up and snack
- 10:30-11:00 : Thank you cards for parents
- 11:00-11:45 : Finish Selfie Expression canvas
- 11:45-12:00 : Wrap up, package up projects

This edible paint is made with milk and neon food coloring. You can also use sweet evaporated milk.

1. Pour milk or sweet evaporated milk into a cup or muffin tin, then add one drop of food coloring. You could also use fruit juices if you don't like food coloring.
2. Paint your popcorn!



Create a Doodlez Color Wheel!

1. Tape off sections of the color wheel and label each color section with a pencil.
2. Doodle different shapes and designs in each color section

The only rule? Use just one color in each section to create a doodley masterpiece!



Totally Tie-Dye

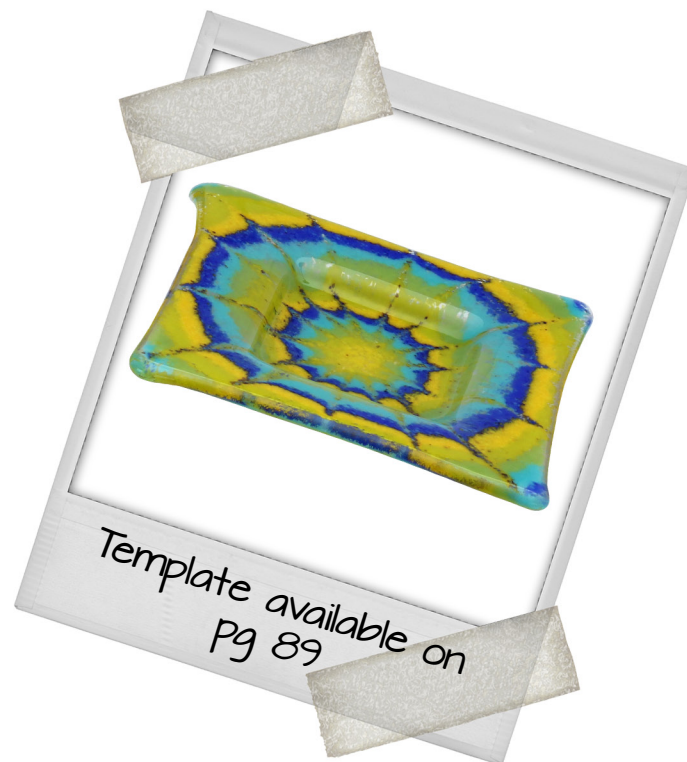

Design courtesy of Bisque Imports

Tie Dye...glass? You bet! This technique creates a totally far out glass project using frit.

MATERIALS

- 1827** Small Square Picture Frame
- CF223F-20** Turquoise Blue Opalescent Frit - Fine
- CF226.72F-20** Lemongrass Opalescent Frit - Fine
- CF226.74F-20** Amazon Green Opalescent Frit - Fine
- CF230.72F-20** Medium Blue Opalescent Frit - Fine
- CF267.72F-20** Sunflower Opalescent Frit - Fine
- GBS6-100** 6 In. Square Clear Transparent
- ST540** Thinfire Shelf Paper

SUPPLIES

- Angled Straw
- Black Sharpie
- Non-Aerosol Hairspray
- Printed Template
- Silver Sharpie
- Toothpick

INSTRUCTIONS

1. Place the 6" clear square over the printed template image. Trace the concentric circle design with a black Sharpie.
2. Use an angled straw to scoop and fill the center circle with Sunflower frit.
3. Repeat step #2 to fill in each concentric circle ring. Begin with Lemongrass frit, followed by Amazon

Green frit, Turquoise Blue frit, and Medium Blue frit. Continue pattern until project is fully covered.

4. Gently pull a toothpick from the center of the project to the outside edge to marbleize the frit. Refer to the bold line design on template.

5. Once completed, spritz project with non-aerosol hairspray. Let dry.

6. Place a piece of Thinfire Shelf Paper on top of the Small Square Picture Frame. Align the project on the Thinfire Paper with the frame shape. Write the camper's name with a Silver Sharpie on the Thinfire. Fire to a Full Fuse using the firing schedule provided:

Seg	Ramp	Temp	Hold
1	300	1000	.30
2	350	1465	.15
3	9999	1050	.60
4	280	800	.10

Geometric Magic

Design courtesy of Bisque Imports

This mixed media project has tons of bold geometric pattern to catch your eye! Fill with a favorite picture and you've created a keepsake!

MATERIALS

- 956 8" Square Tile
- 1827 Small Square Picture Frame
- 8013 Art Tape Assortment
- 8301 E-6000 Adhesive
- CFKITC Frit Kit - Coarse
- GBITSASST Assorted Bits
- GSTRIP200 White Opalescent Strips
- OS468 Deep Turquoise
- RAA-5107 Primary Yellow
- RAA-5109 Cadmium Orange
- RAA-5120 Mars Black
- RAA-5121 Titanium White
- RAQUA144 Aqualon Assortment
- SP-8234 Glas Tac
- ST340 1" Running Pliers
- ST352 Pistol Grip Glass Cutter
- ST356 Wheel Mosaic Cutter
- ST540 Thinfire Shelf Paper
- UM958 Blue

SUPPLIES

- Black Sharpie
- Pencil
- Ruler
- Silver Sharpie
- Water



INSTRUCTIONS

Glass Frame Border:

1. Place a sheet of thinfire paper onto the 8" Square tile. Use this surface as a portable assembly surface for building your glass project.
2. Position the frame in the center of the tile, directly on the thinfire paper. Trace the frame shape with a pencil, then set aside.
3. Measure out four 5 1/2" strips, and mark each point with a black Sharpie.
4. Place each strip flat onto a cutting surface. Use a Pistol Grip Glass Cutter to score a line at every marked point along each strip. Break along each score with the Running Pliers.
5. Score and cut an assortment of bits diagonally in half to create triangles.



Geometric Magic Continued

Seg:	Ramp	Temp	Hold
1	300	1000	.30
2	350	1380-1395	.10
3	9999	1050	.60
4	250	800	.10

Acrylic Frame:

1. Wipe frame with a damp sponge to prepare surface for painting.
2. Use 3/4" Art Tape to mask the border around frame.
3. Use 1/8" Art Tape to mask horizontal stripes across frame.
4. Alternate using Primary Yellow, Deep Turquoise, and Blue to fill in each unmasked stripe.
5. Use an assortment of acrylic paints to create different geometric patterns across each stripe. Refer to the template provided, or create your own custom pattern!
6. For this project, we created each pattern using Deep Turquoise, Primary Yellow, Cadmium Orange, Mars Black, Titanium White, and Blue. Let dry.
7. Once dry, remove all Art Tape from frame.
8. Paint the frame border with Mars Black. Let dry.
9. Once the paint has dried, use E-6000 to attach your fired glass border to the frame. Attach backing with E-6000, assemble frame, and enjoy!

6. Along each strip, arrange the bits in different patterns. Alternate colors, or try a mixture of colors for a festive look. Secure bits with a small amount of Glas Tac.

7. Add pieces of coarse frit to create dots along the patterns, if desired. Secure with Glas Tac.

8. Arrange each strip to create a border within the traced frame shape (see diagram). Secure the strips together with Glas Tac and allow to dry.

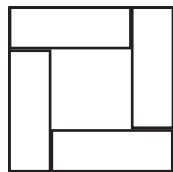

9. Write the camper's name with a Silver Sharpie on the Thinfire, and transfer project to the kiln. Fire to a Full Fuse using the firing schedule provided:

BFF

Design courtesy of Bisque Imports

Love is sweeter when it's shared over a cup of something warm! Campers will love creating this cute mug for the best friend in their life.

MATERIALS

- 2749** Curvy Coffee Mug
- 8006** 3/4" Decorative Stickies Assortment
- CN101-8** Light Heather
- CN253-8** Dark Black
- CN292-8** Bright Purple
- CN343-8** Dark Pink
- CN373-8** Dark Honeysuckle
- RAQUA144** Aqualon Assortment
- SP-456** Squeegee

SUPPLIES

- Pin
- Shaving Cream
- Water

TIP: For a funkier look, keep the shaving cream textured.

INSTRUCTIONS

1. Lightly wipe ware with a damp sponge to prepare surface for painting.
2. Firmly apply Decorative Stickies in scattered areas on the mug surface.
3. Dispense shaving cream onto a flat, easy-to-clean surface. Dispense enough to fill an area large enough to cover the mug. Smooth with a flat object, like a squeegee.
4. Dispense a small amount of Light Heather, Bright Purple, and Dark Pink directly onto the shaving



cream. Feel free to experiment with more colors!

5. Use a paintbrush handle to gently swirl the paints into each other. Be careful not to muddle the color.
6. Firmly twirl and twist the mug onto the shaving cream mixture to coat the entire surface. Reapply to add greater texture. Once done, gently lift the mug.
7. Using a small amount of water, gently rinse off the shaving cream to reveal your design. Set aside to dry.
8. Once dry, use a pin to gently remove each sticker.
9. Paint a heart with 3 coats of Dark Honeysuckle.
10. Paint "BFF" over the heart with 2 coats of Dark Black.
11. Paint the inside of the mug with 3 coats of Light Heather. Let dry.
12. Dip in Pure Brilliance and fire to Cone 06.

Totally Charming

Design courtesy of Bisque Imports

With this cute project, your BFF will never be far from your heart!

MATERIALS

- 6069** Double Heart Bead (2)
- OS435** Dark Yellow
- OS469** Light Turquoise
- OS558** Miami Pink
- OS569** Concord
- RAQUA144** Aqualon Assortment
- SG880** Crystal Sparkler

SUPPLIES

- Assorted String
- Pencil
- Water

INSTRUCTIONS

1. Lightly wipe ware each bead with a damp sponge to prepare for painting.
2. If desired, use a pencil to lightly sketch a design onto each bead.
3. Paint one bead completely with Dark Yellow. Paint the other bead with Light Turquoise. Let dry.
4. On each bead, paint an inner heart with Miami Pink. Let dry.



5. Paint over each bead with Crystal Sparkler. Let dry.
6. With a detail brush and Concord, paint "Best" on one heart bead, and "Friends" on the other bead. Let dry.
7. Create a necklace or a bracelet using braided string.

Monogram Me

Design courtesy of Bisque Imports

This perfect paisley print will be an instant hit! Stripes, dots, and chevron would also work well.

MATERIALS

- 9700** 6 Inch Curly Letter Set A-Z
- AS959** Duncan Hi-Gloss Sealer
- D31209** Aleene's Glossy Decoupage
- RAA-5118** Naples Yellow
- RAQUA144** Aqualon Assortment
- SP-SS** Sugar & Spice 12" x 12" Paper Pack
- SP-SY** Serendipity 12" x 12" Paper Pack
- SP-WC** Watercolor 12" x 12" Paper Pack

SUPPLIES

- Alphabet Stickers
- Glue Stick
- Pencil
- Scissors
- Water

INSTRUCTIONS

1. Lightly wipe ware with a damp sponge to prepare surface for painting.
2. Position each curly letter on a sheet of craft paper. Trace the letter using a pencil, then cut out with scissors.
3. Using a glue stick, apply glue to the backside of each letter shape. Immediately position the letter



shape onto its respective bisque letter. Flatten the letter shape firmly onto the surface of each bisque letter. Let dry for a few minutes.

4. Apply one coat of Aleene's Glossy Decoupage over the letter shape. Let this dry completely.
5. Cut out designs or shapes from an assortment of craft paper. Use a glue stick to adhere each design or shape onto the letter.
6. Apply one coat of Aleene's Glossy Decoupage over the design cut-outs. Let this dry completely.
7. Use a paintbrush to paint the edges and backside of the curly letter with 2 coats of Naples Yellow. Once dry, apply one coat of Hi-Gloss Sealer to each painted surface. Let dry.
8. Once project is completely dry, personalize the letter with a name using alphabet stickers.

Glamour Shots

Design courtesy of Bisque Imports

Ask campers to bring in a few special shots with their friends to create their own photobooth!

MATERIALS

- 956 8" Square Tile
- BIM120** Starry Night Tile Assortment
- BIM288** Fresh Linen Mosaic Tiles 10 mm
- BIM291** Clean Slate Mosaic Tiles 10 mm
- BIM343** Onyx Square Mosaic Tiles 12 mm
- BIM514** Mystic Crystal Glass Mosaic Tiles 10 mm
- BIM70204-0003** Black Grout
- BIM72064** Clear Cathedral Nibbles & Bits
- BIM72946-0006** Weldbond
- D15481** Aleene's Glass & Bead Glue
- D31210** Aleene's Matte Decoupage
- RAA-5103** Cobalt Blue
- RAQUA144** Aqualon Assortment
- SG881** Glittering Silver Sparkler
- ST356** Wheel Mosaic Nipper

SUPPLIES

- Assorted Photos
- Glue Stick
- Latex Gloves
- Paper Towels
- Plastic Spoon (to mix grout)
- Scissors
- Self-Laminating Sheets (optional)
- Small Disposable Bowl (for grout mix)
- Water

TIP: If using an inkjet printer, prevent ink bleeding by sealing each photo with a self-laminating sheet before adhering to tile.



INSTRUCTIONS

1. Cut out and position photos onto the tile. Use an assortment of small photos, or one large photo. Adhere to tile with a glue stick. For this project, we used four 2.5" square photos.
2. Using a paintbrush, apply a coat of decoupage over the tile to seal photo to surface. Allow decoupage to dry completely.
3. Use Aleene's Glass & Bead glue as adhesive to adhere Clear Cathedral bits over each photo. Leave a small space in between each piece for grout. If needed, use a Wheel Mosaic Nipper to nip pieces to the desired size.
5. Use Weldbond adhesive to adhere Onyx Square tiles in between and along the right and left sides of the photo(s).
6. Alternate adhering Fresh Linen and Mystic Crystal Glass tiles along the top and bottom of the



Glamour Shots Continued

Tip: Set up a photo booth for campers. Hang a sheet and pick up some props from the dollar store, or make your own by printing our templates on page 90 on cardstock and attaching wooden dowels! Your campers will love hamming it up for the camera. Have pictures printed and ready for parents when they arrive.

photo(s).

7. Adhere Clean Slate tiles in the remaining area on the right and left side of photo(s).
8. Line the top and bottom edge of tile with an assortment of Starry Night tiles.
9. Let your mosaic project dry for 24 hours. Then, follow the grouting instructions found on page 37 to finish using Black Grout.
10. Let grout dry to the touch. Once dry, use a paintbrush to paint each Starry Night tile row with Glittering Silver Sparkler. Paint the edges and backside of tile with 2 coats of Cobalt Blue.

Money saving tip - order grout in the 1 pound size to save up to \$1.00 per camper! (covers 4-6 projects depending on size)

Selfie Expression

Design courtesy of Bisque Imports

What better way for campers to express themselves than through art? This cute self portrait takes a current trend and turns it into an artistic expression.

MATERIALS

- AA7010** Canvas Panel 12" x 12"
- AS959** Duncan Hi-Gloss Sealer
- OS435** Dark Yellow
- OS438** Orange Peel
- OS463** Medium Green
- OS467** Light Brown
- OS468** Deep Turquoise
- OS471** Medium Brown
- OS475** Charcoal
- OS476** Black
- OS568** Fire Thorn
- OS569** Concord
- RAQUA144** Aqualon Assortment

SUPPLIES

- Dice
- Pencil
- Water

INSTRUCTIONS

1. Play the dice game to determine the eyes, nose and mouth, hair and accessory of your unique selfie.



Selfie Dice Game : Roll one dice 4 times. The first roll number determines your selfie's eyes, the second determines your selfie's nose and mouth, the third your selfie's hair, and the fourth determines your selfie's accessory. Mix n' match using the templates provided to make your own unique selfie!

2. Using a pencil, sketch out each part of your selfie portrait onto the canvas surface.
3. For this project, we used Light Brown to paint the face and neck.
4. With an equal mix of Fire Thorn and Medium Brown, paint the hair. Once dry, add Medium Brown accent lines.
5. Paint the earphone pads with Charcoal.



Selfie Expression Continued

6. Use Concord to paint the earphones cable wire and the frame line next to each earphone pad.
7. Paint the rest of the earphones frame with Black.
8. Paint the shirt with Orange Peel.
9. Use a detail brush and Black to paint the eyes, nose, and mouth.
10. Paint the background with Deep Turquoise.
11. With a detail brush and Black, outline the project.
12. In the background, add a border and accent elements - like music notes - or anything else you would like to match your selfie portrait. Let dry.
13. Once your project is completed and fully dry, cover the canvas surface with a coat of Duncan's Hi-Gloss Sealer.

Material List

BISQUE

- 956** 8" Square Tile
- 1827** Small Square Picture Frame
- 2749** Curvy Coffee Mug
- 6069** Double Heart Bead (2)
- 9700** 6 Inch Curly Letter Set A-Z

PAINT

- CN101-8** Light Heather
- CN253-8** Dark Black
- CN292-8** Bright Purple
- CN343-8** Dark Pink
- CN373-8** Dark Honeysuckle
- OS431** White
- OS435** Dark Yellow
- OS438** Orange Peel
- OS449** Bright Red
- OS463** Medium Green
- OS467** Light Brown
- OS468** Deep Turquoise
- OS469** Light Turquoise
- OS471** Medium Brown
- OS475** Charcoal
- OS476** Black
- OS558** Miami Pink
- OS564** Pansy
- OS568** Fire Thorn
- OS569** Concord
- OS586** Ultra Marine
- RAA-5103** Cobalt Blue
- RAA-5107** Primary Yellow
- RAA-5109** Cadmium Orange
- RAA-5118** Naples Yellow
- RAA-5120** Mars Black
- RAA-5121** Titanium White
- UM958** Blue
- SG880** Crystal Sparkler
- SG881** Glittering Silver Sparkler

CRAFT & SUPPLIES

- 8006** 3/4" Decorative Stickies Assortment
- 8013** Art Tape Assortment
- 8301** E-6000 Adhesive
- AA7010** Canvas Panel 12" x 12"
- AS959** Duncan Hi-Gloss Sealer
- D15481** Aleene's Glass & Bead Glue
- D31209** Aleene's Glossy Decoupage
- D31210** Aleene's Matte Decoupage
- RAQUA144** Aqualon Assortment
- SP-456** Squeegee
- SP-8234** Glas Tac
- SP-SS** Sugar & Spice 12" x 12" Paper Pack
- SP-SY** Serendipity 12" x 12" Paper Pack
- SP-WC** Watercolor 12" x 12" Paper Pack
- ST340** 1" Running Pliers
- ST352** Pistol Grip Glass Cutter
- ST356** Wheel Mosaic Cutter
- ST540** Thinfire Shelf Paper

WARM GLASS

- CF223F-20** Turquoise Blue Opalescent Frit - Fine
- CF226.72F-20** Lemongrass Opalescent Frit - Fine
- CF226.74F-20** Amazon Green Opalescent Frit - Fine
- CF230.72F-20** Medium Blue Opalescent Frit - Fine
- CF267.72F-20** Sunflower Opalescent Frit - Fine
- CFKITC** Frit Kit - Coarse
- GBS6-100** 6 In. Square Clear Transparent
- GBITSASST** Assorted Bits
- GSTRIP200** White Opalescent Strips

MOSAICS

- BIM120** Starry Night Tile Assortment
- BIM288** Fresh Linen Mosaic Tiles 10 mm
- BIM291** Clean Slate Mosaic Tiles 10 mm
- BIM343** Onyx Square Mosaic Tiles 12 mm
- BIM514** Mystic Crystal Glass Mosaic Tiles 10 mm
- BIM70204-0003** Black Grout
- BIM72064** Clear Cathedral Nibbles & Bits
- BIM72946-0006** Weldbond

SUMMER



TEMPLATES

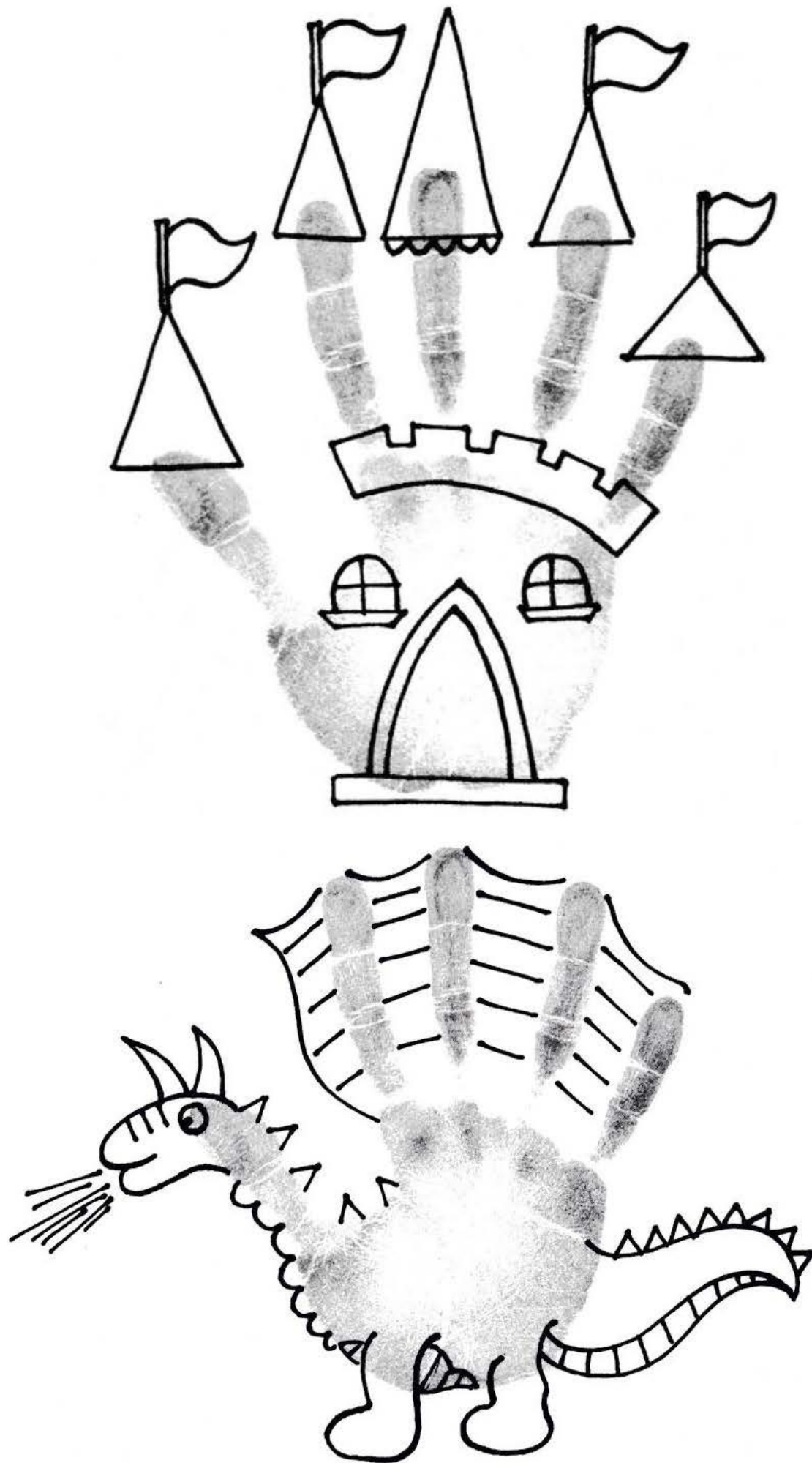

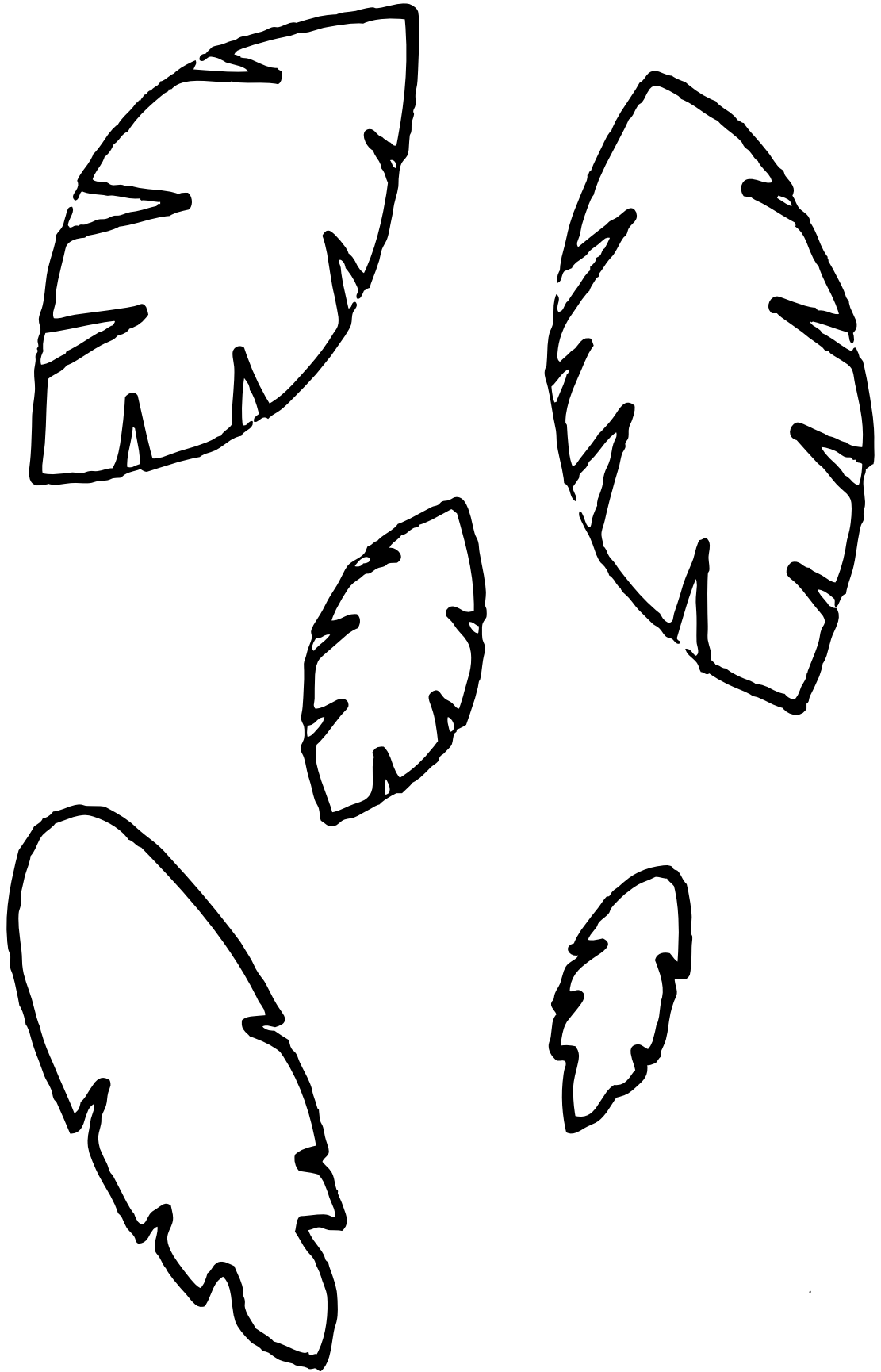

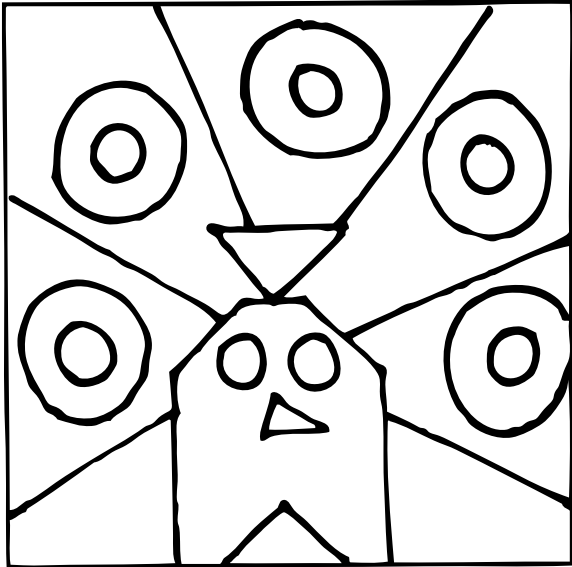

HANGMAN

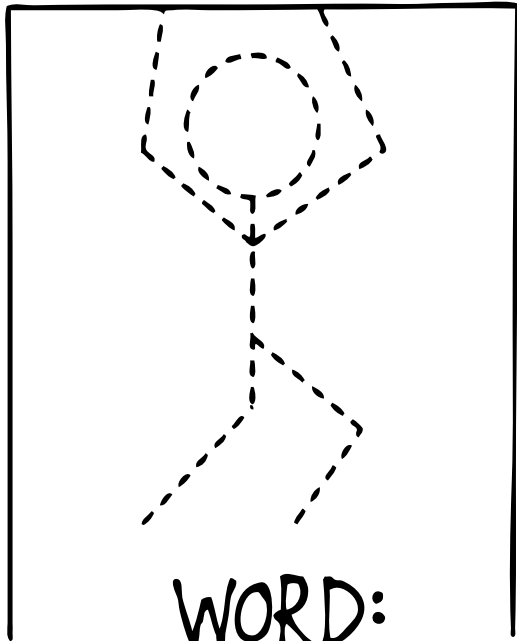

WORD:

- | | | |
|---|---|---|
| A | B | F |
| D | E | H |
| G | H | L |
| J | K | O |
| M | N | R |
| P | Q | U |
| S | T | X |
| V | W | |
| Y | Z | |

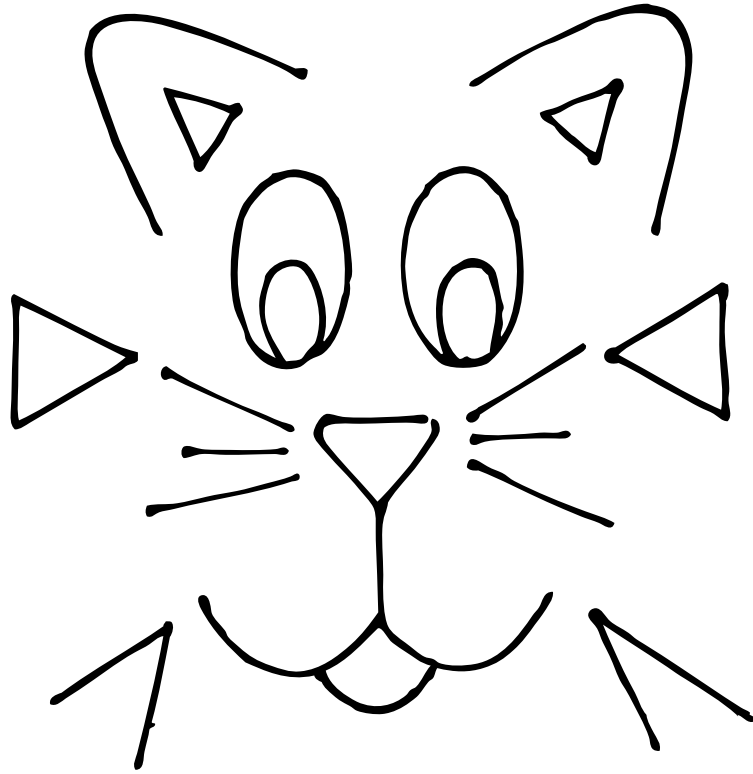

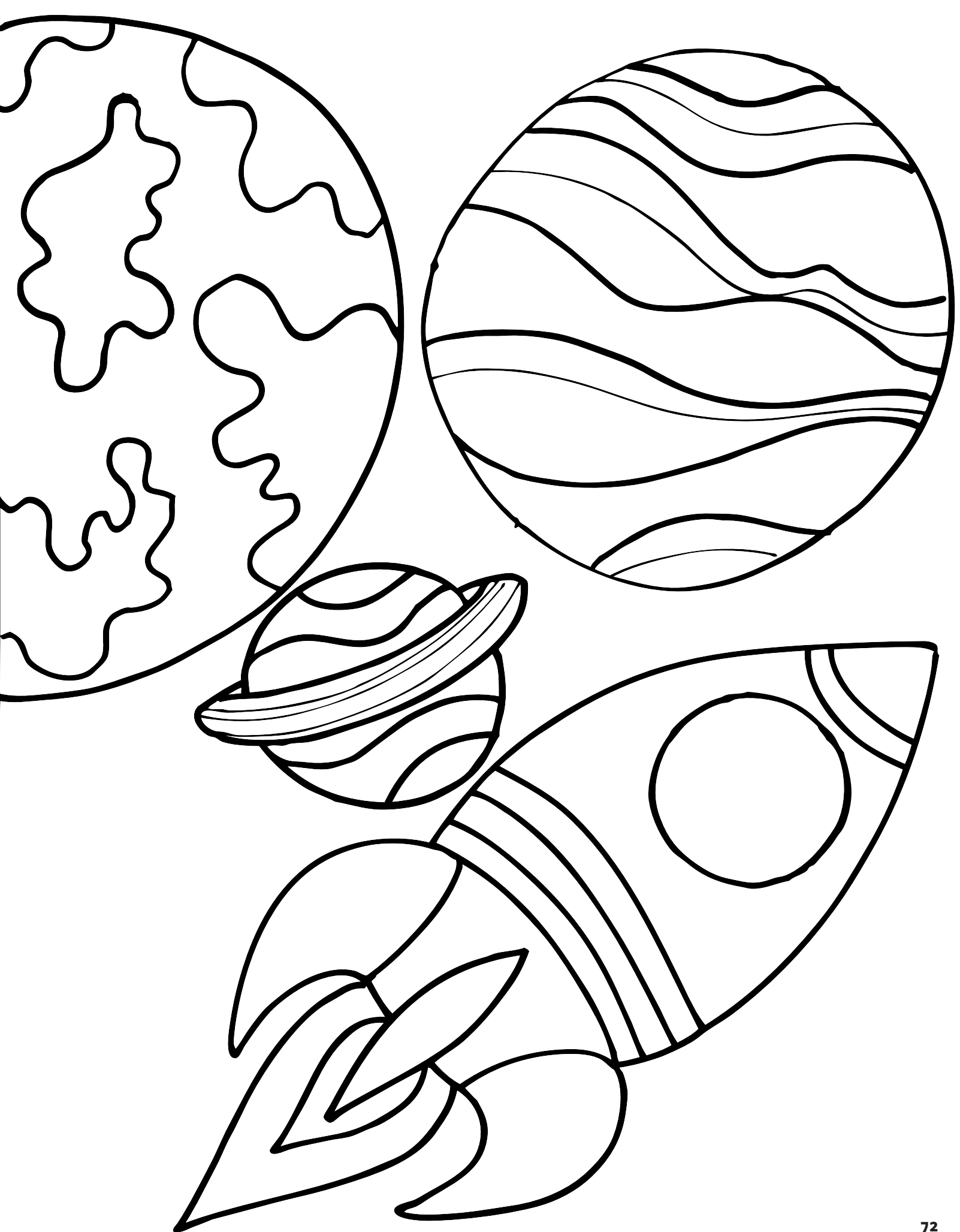















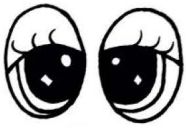



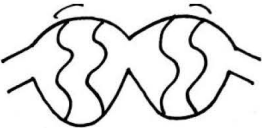



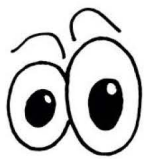





Y

U

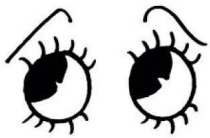
M

PIE FACE DICE GAME

	ROLL #1	ROLL #2	ROLL #3	ROLL #4
	EYES	MOUTH	TOPPING #1	TOPPING #2
			 Cherries	 Chocolate Chips
			 Blueberries	 Chocolate Drizzle
			 strawberries	 Banana Slices
			 Apple Slices	 Whip Cream
			 Raspberries	 Ice Cream
			 Lemon & Lime Slices	 Pecans

Pie Face Dice Game : Roll one dice 4 times. The first roll number determines your pie face's eyes, the second determines your pie face's mouth, the third your pie's first topping, and the fourth determines your pie's second topping. Mix n' match using the templates provided to make your own unique pie face!



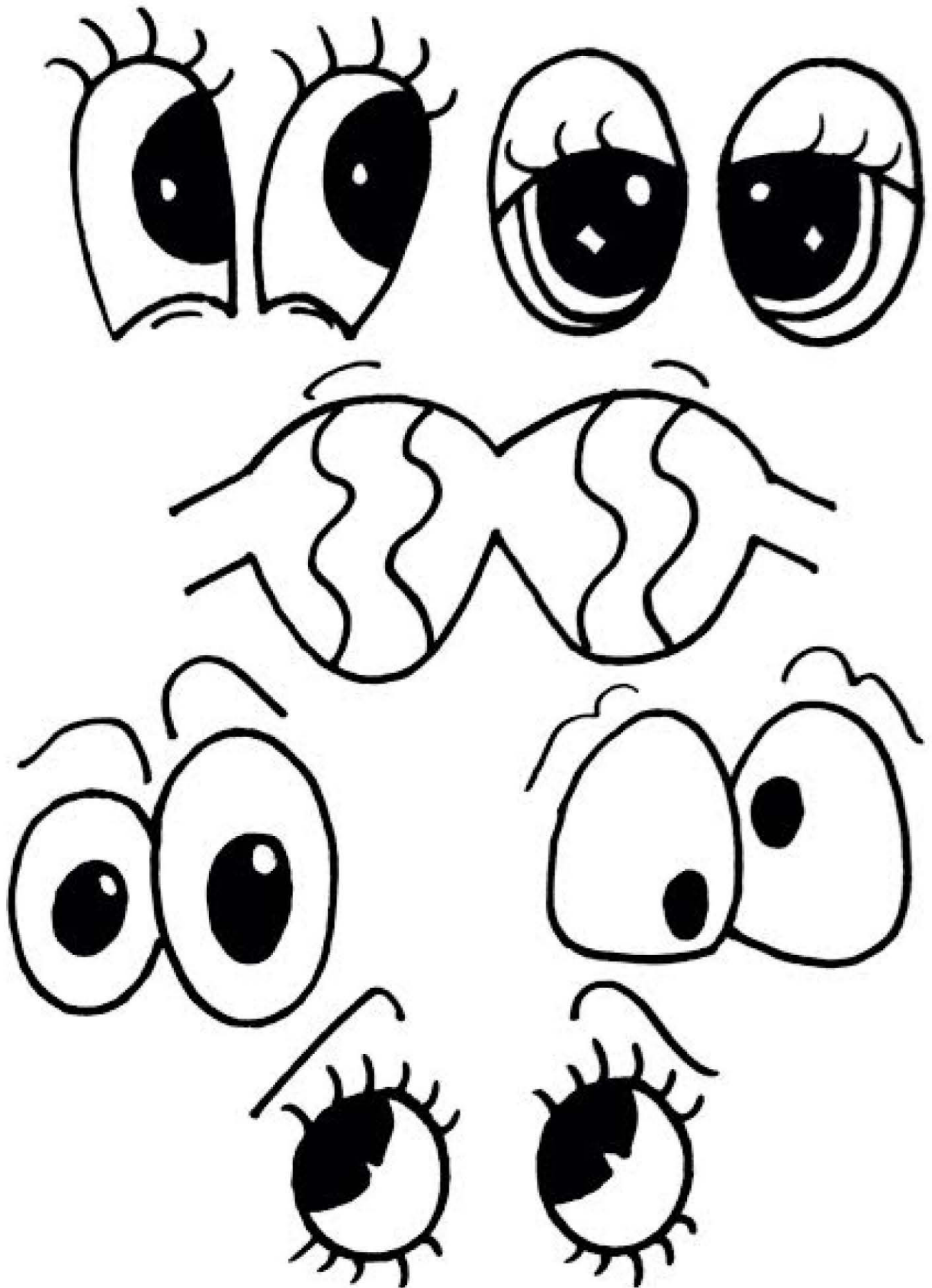

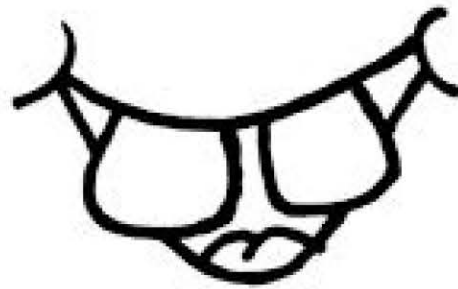
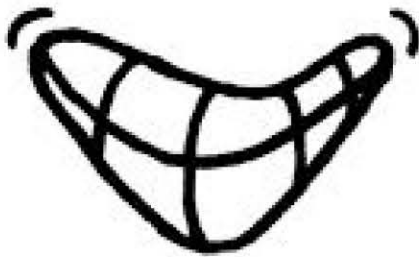
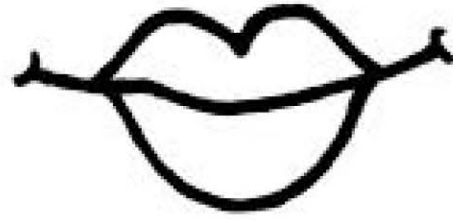

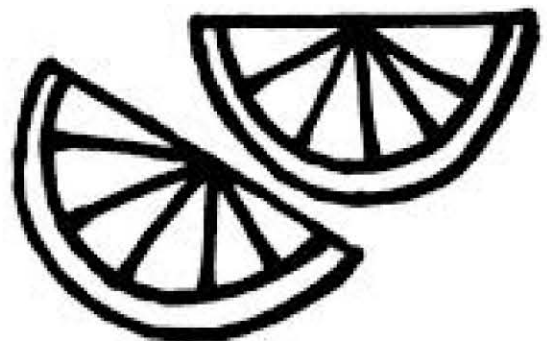
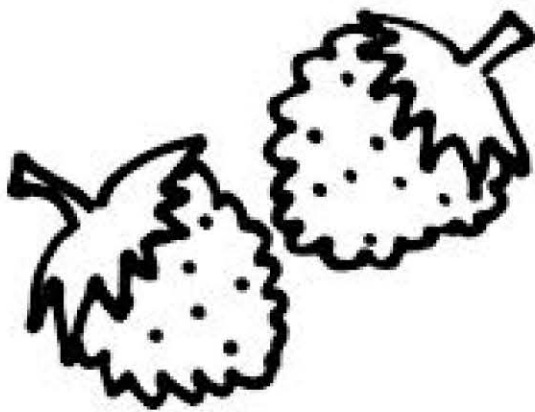
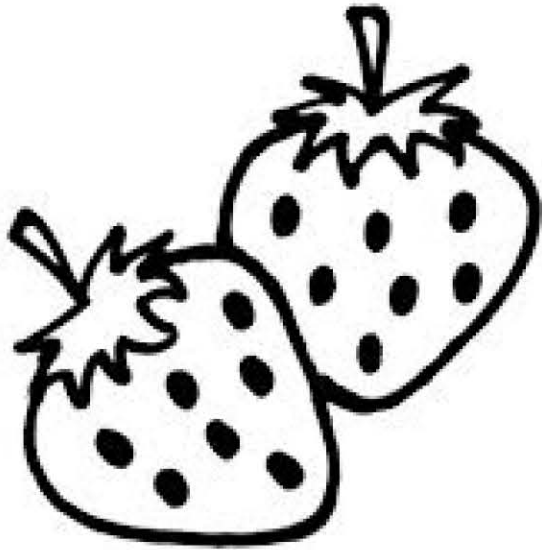
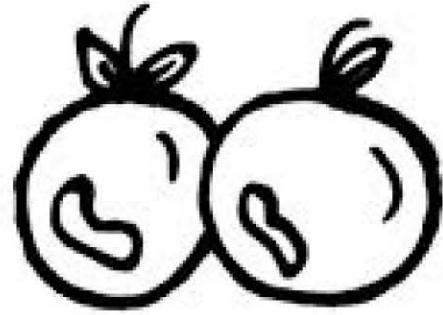

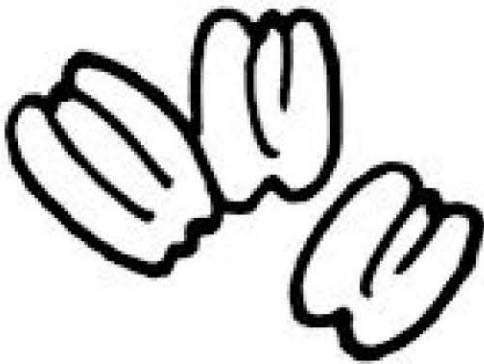
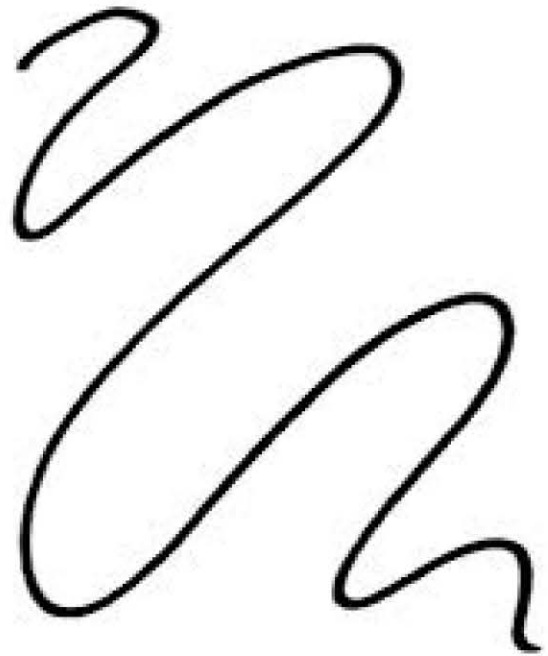
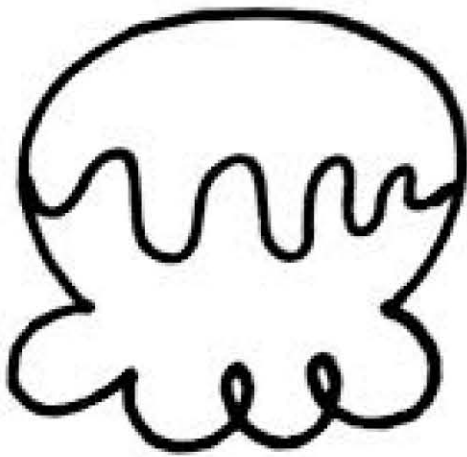
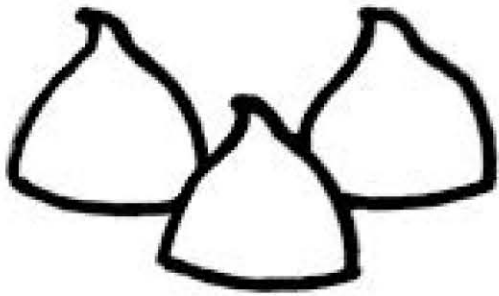

TIE DYE TECHNIQUES

Bullseye

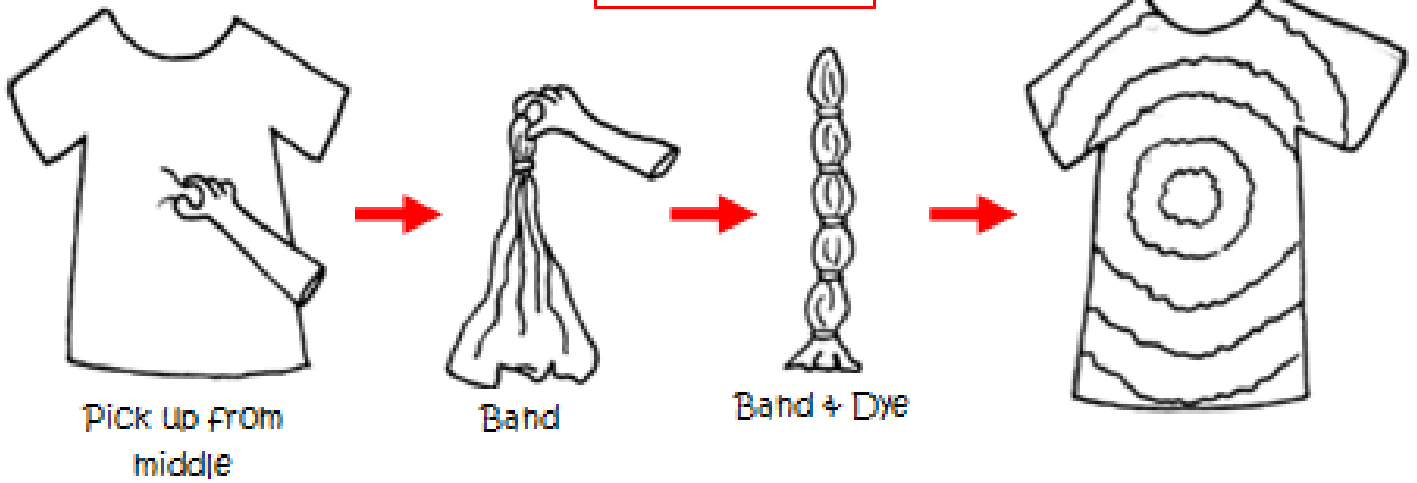

Spiral

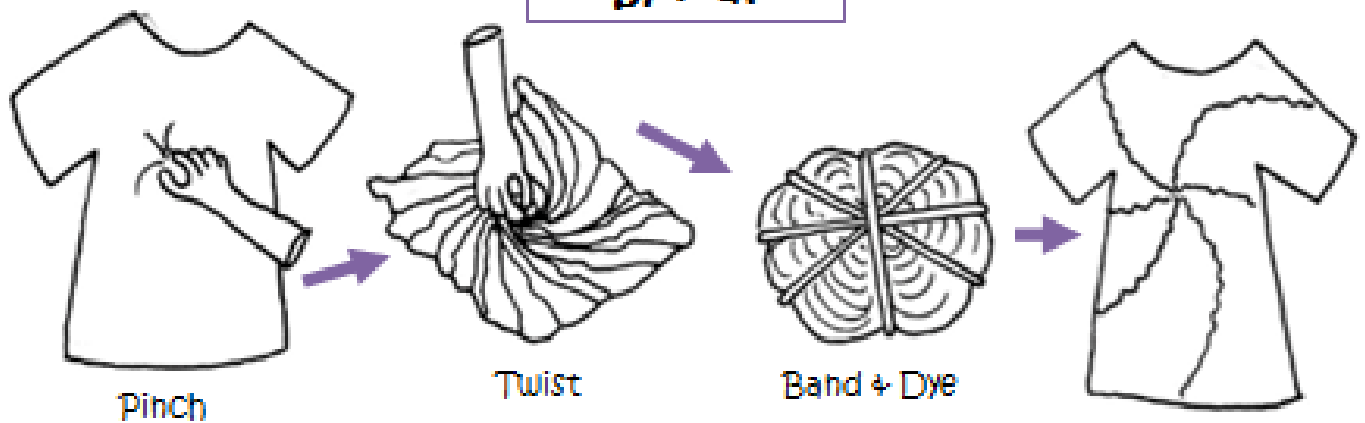

Double Spiral

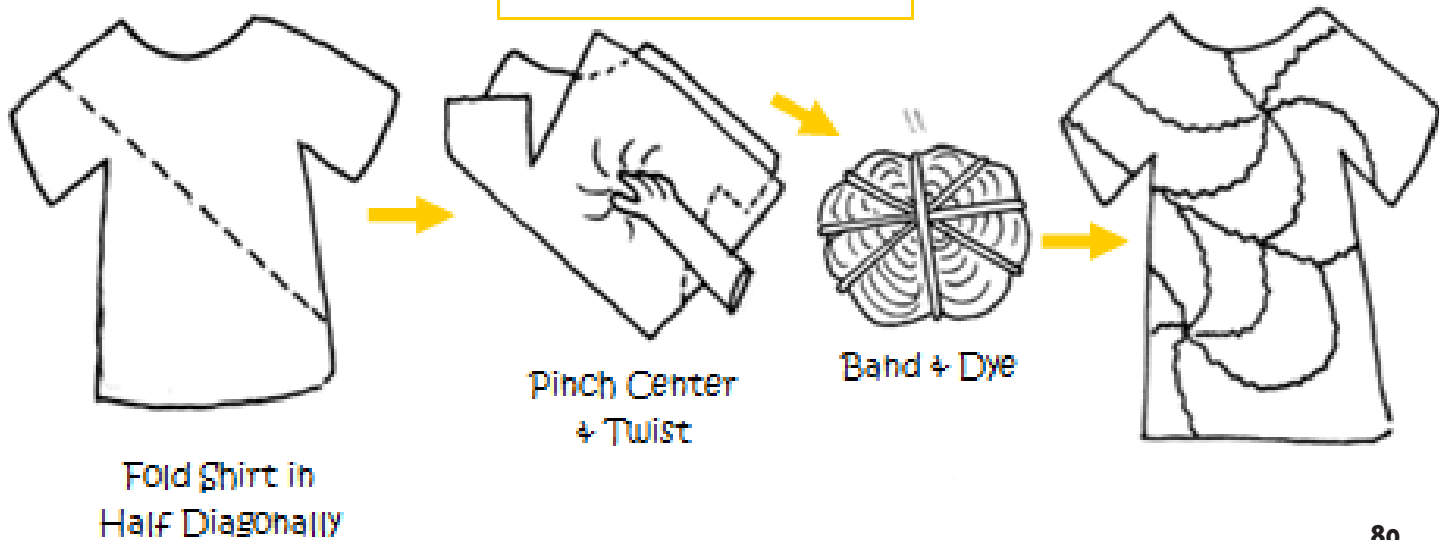

Vertical Stripes

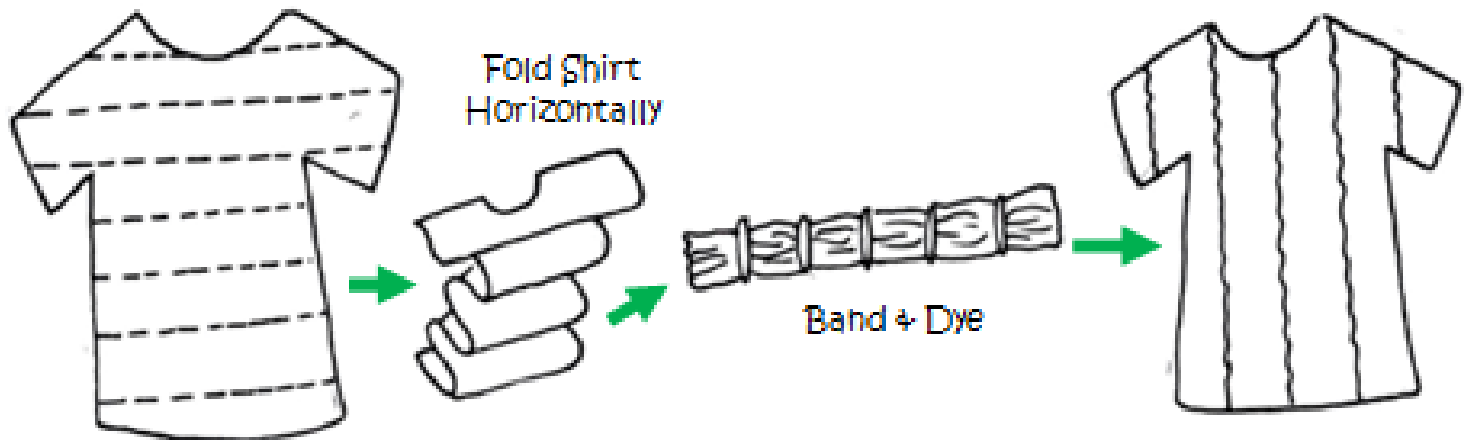

Horizontal Stripes

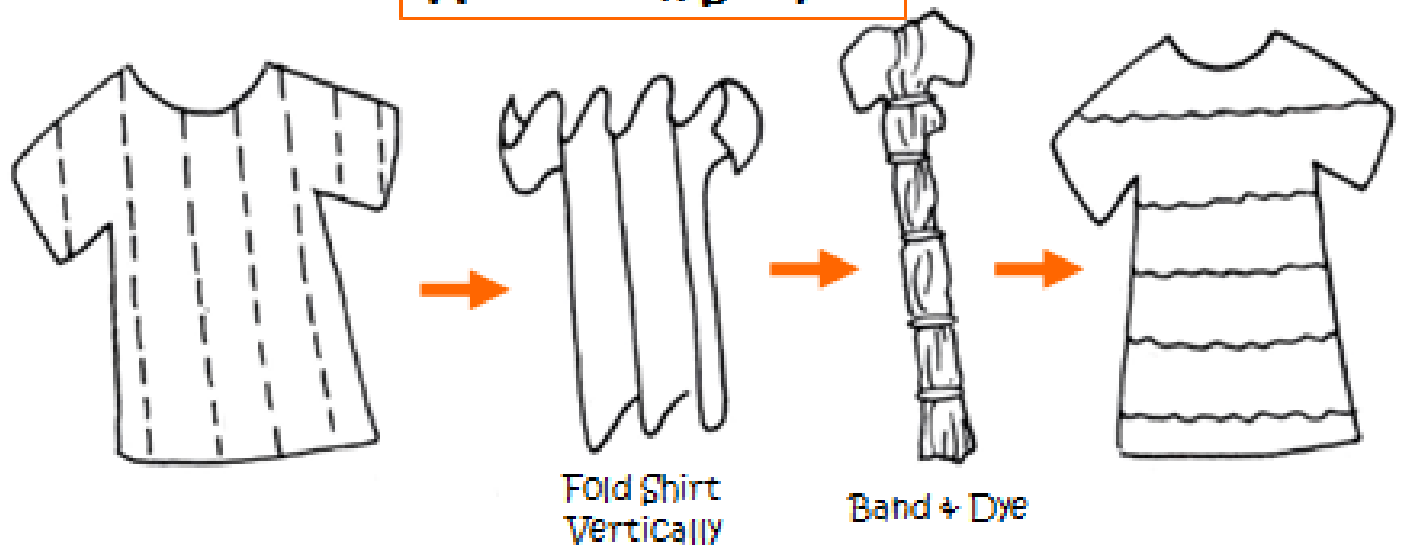

Crumple / Bunching

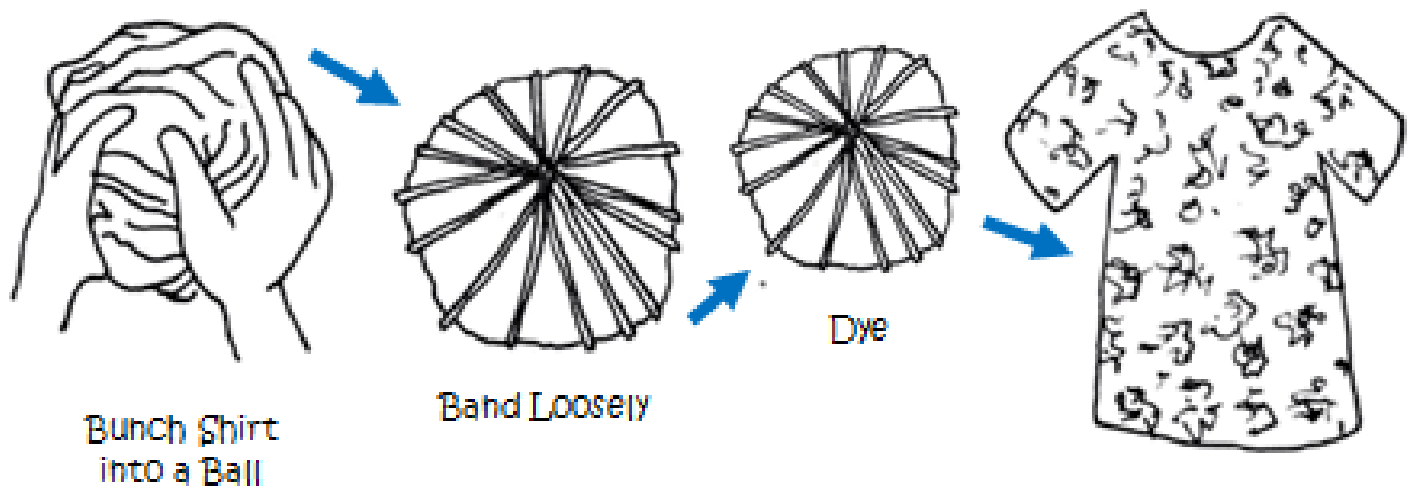

Polka Dots

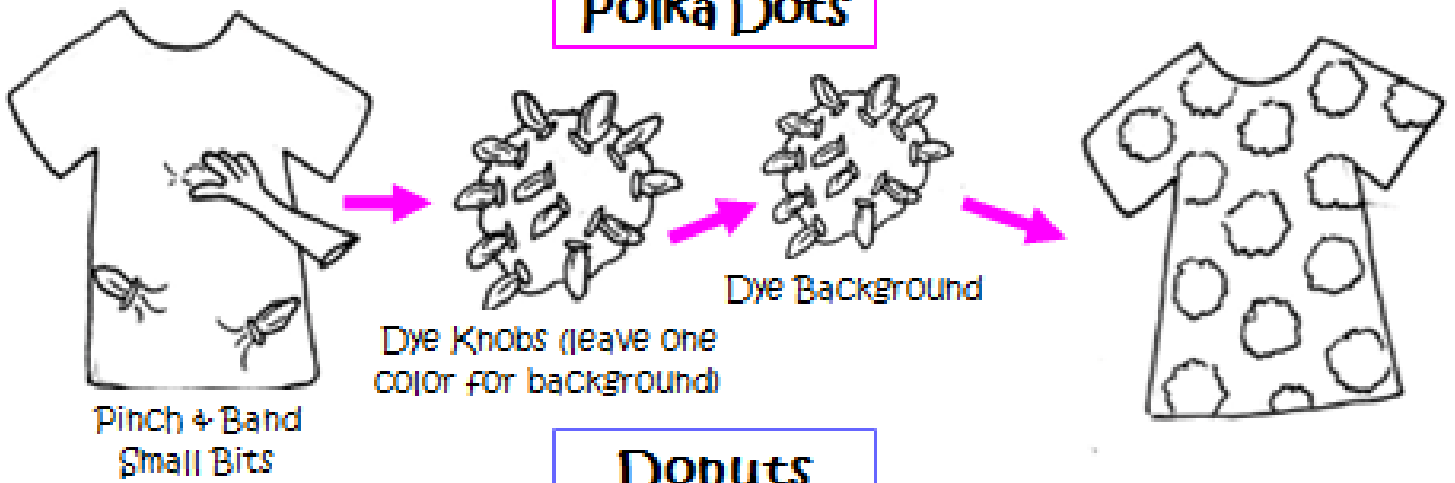

Donuts

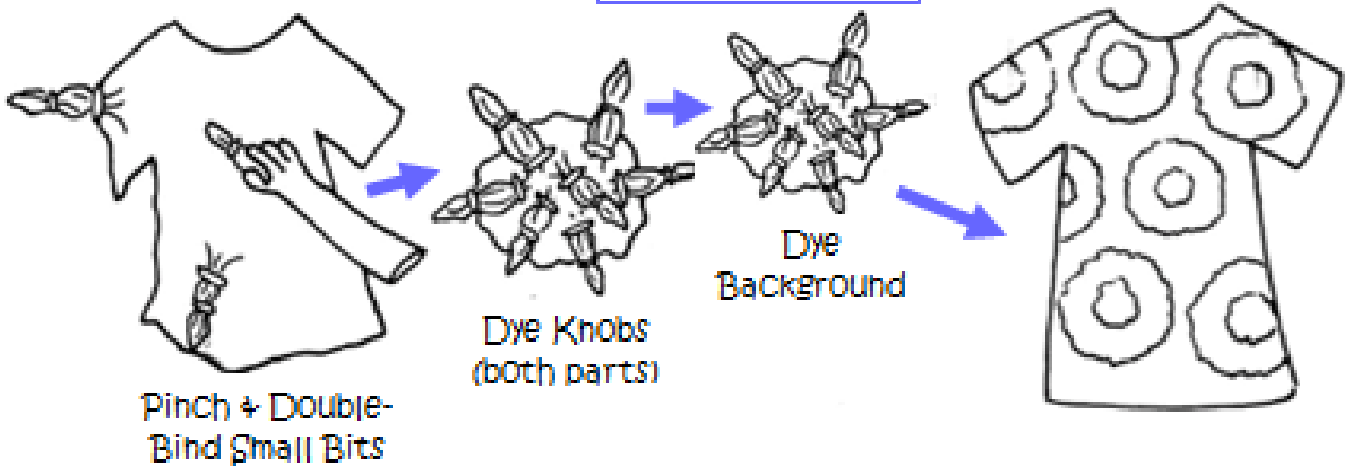

Rainbow

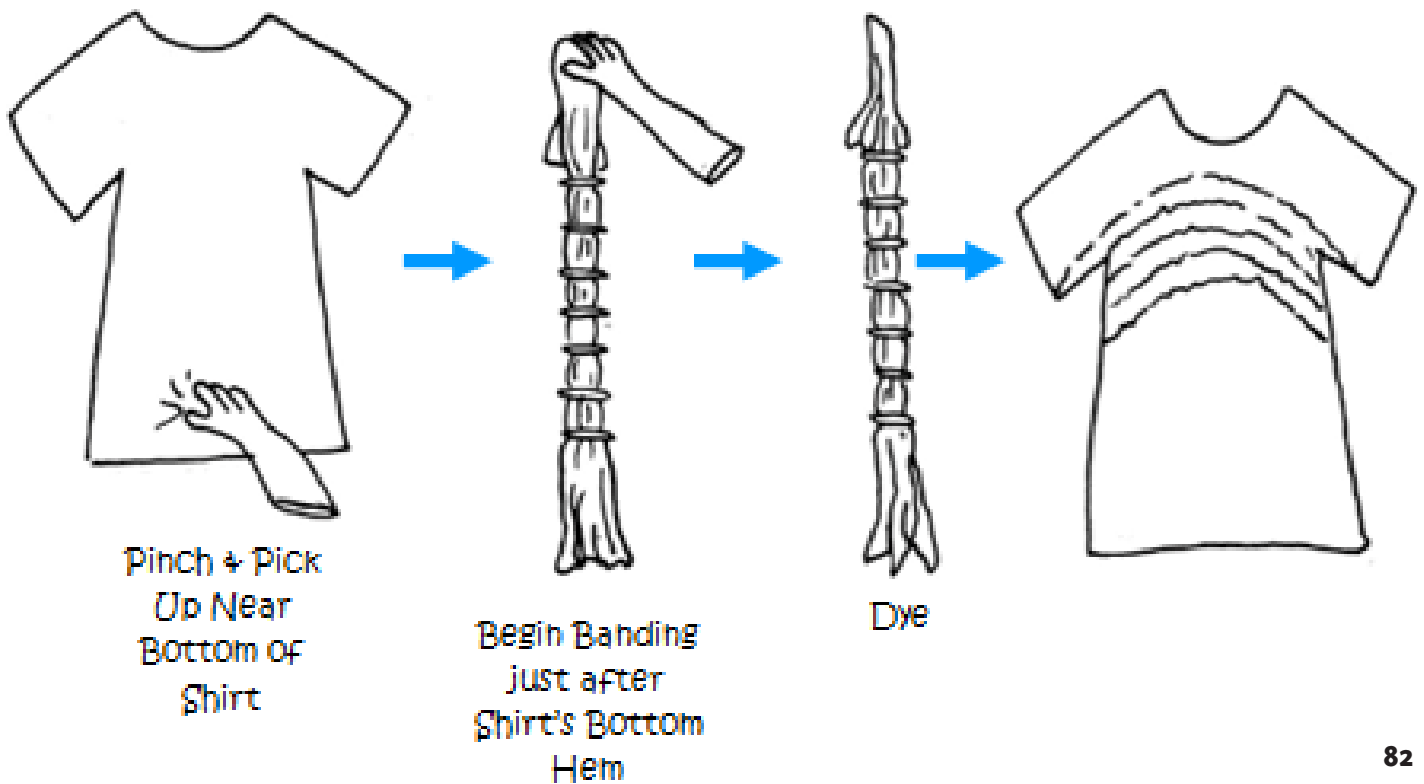

FUN FOOD

B I N G O

		Free Space		

FUN FOOD BINGO Instructions:

1. Print a FUN FOOD BINGO template for each child.
2. To make the FUN FOOD BINGO board, have each child draw or write a food item (from the list below) in a single square on their BINGO board.
3. Print out the list of food items (two of each food item) and cut into separate strips. Place strips into a bowl, to be picked at random while playing. Print and cut out the BINGO letters (five of each letter), then place in another bowl.
4. Create 'markers' by cutting out small squares from paper. Give each child a handful of markers to play.

5. **To play:** On each turn, the BINGO caller will pick both a food item and a BINGO letter from each bowl at random. These animal-letter combinations should occasionally coordinate with a square on the BINGO board. The goal is to cover five squares in a vertical, horizontal, or diagonal row. Shout "Bingo!" when you get five in a row, loud enough for the caller to hear. In the chance that two children get five in a row at the same time, the winner is the person who shouts "Bingo!" first.

List of Food Items:

Bananas	Bananas	Fish	Fish
Cherries	Cherries	Fries	Fries
Apple	Apple	Strawberry	Strawberry
Raspberry	Raspberry	Cupcake	Cupcake
Pizza	Pizza	Ice Cream	Ice Cream
Hamburger	Hamburger	Lollipop	Lollipop
Chocolate	Chocolate	Carrot	Carrot
Bread	Bread	Donut	Donut
Pasta	Pasta	Pineapple	Pineapple
Orange	Orange	Mushroom	Mushroom
Peach	Peach	Bacon	Bacon
Grapes	Grapes	Hot Dog	Hot Dog

Bingo Letters:

B	B	B	B	B
I	I	I	I	I
N	N	N	N	N
G	G	G	G	G
O	O	O	O	O

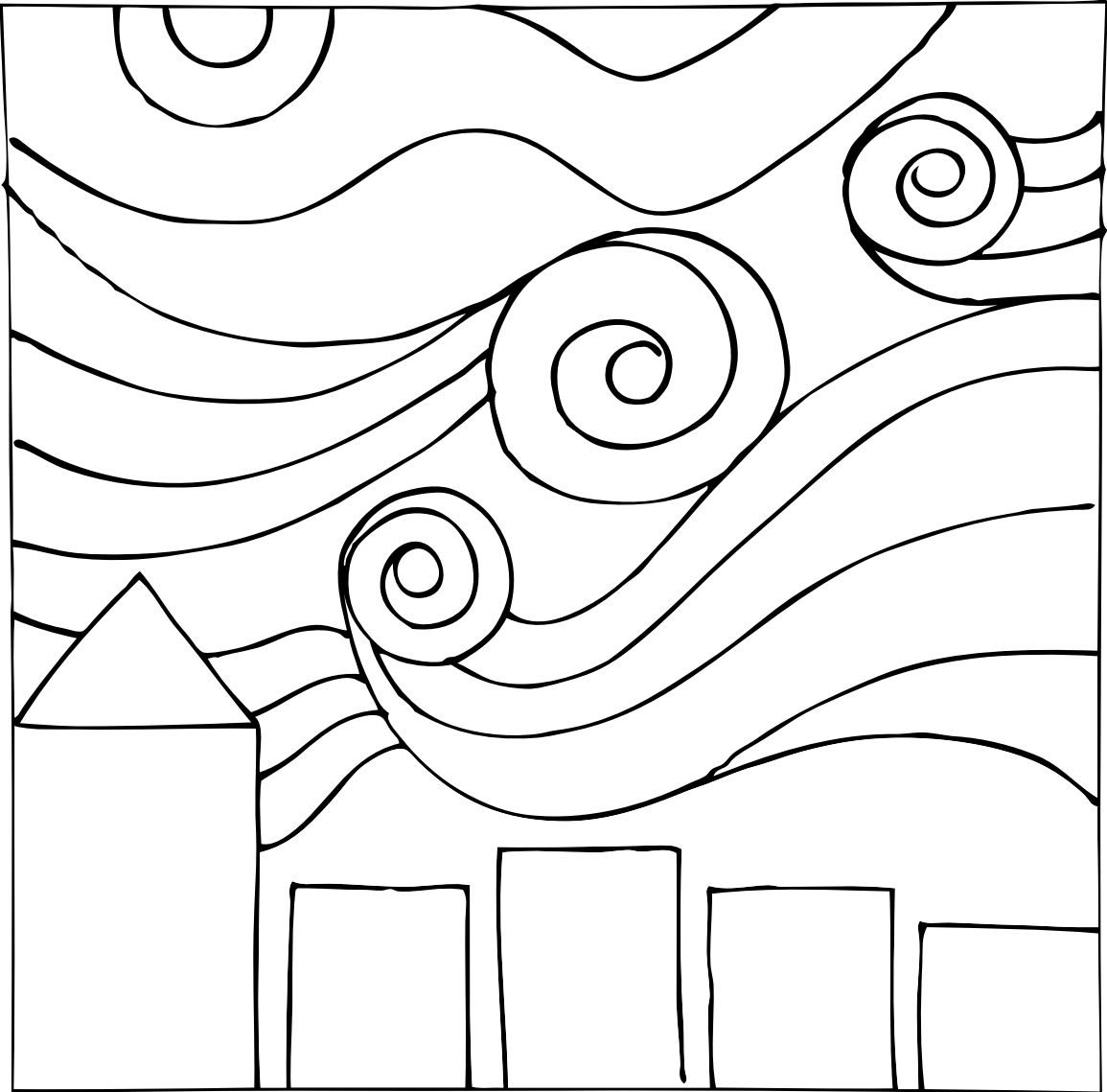

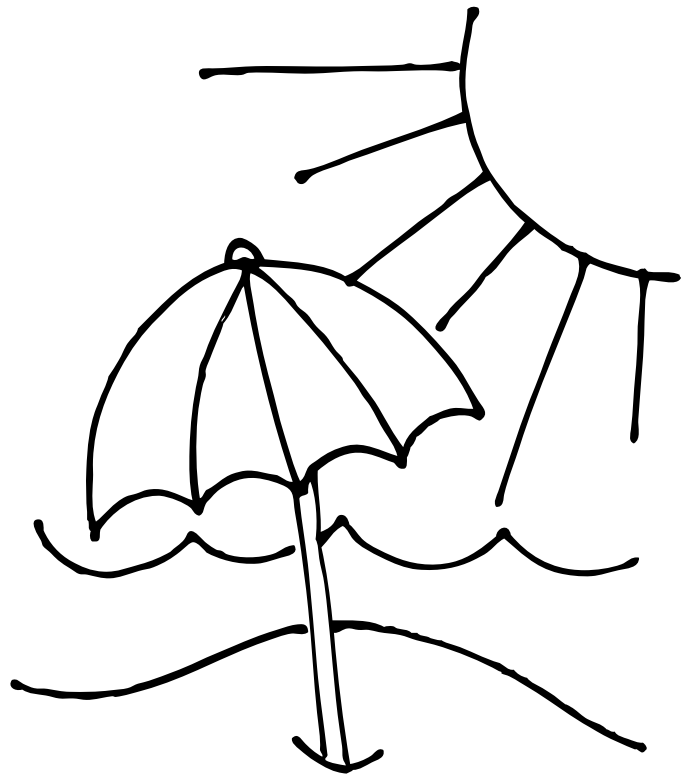
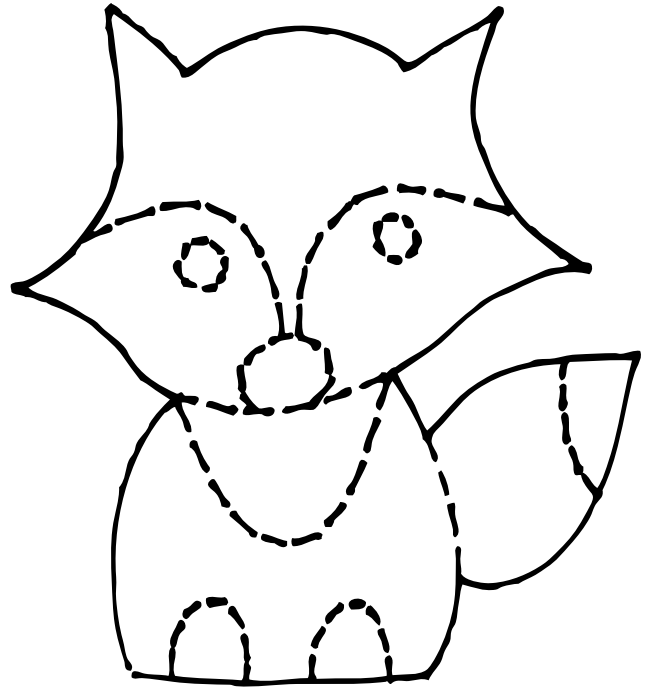
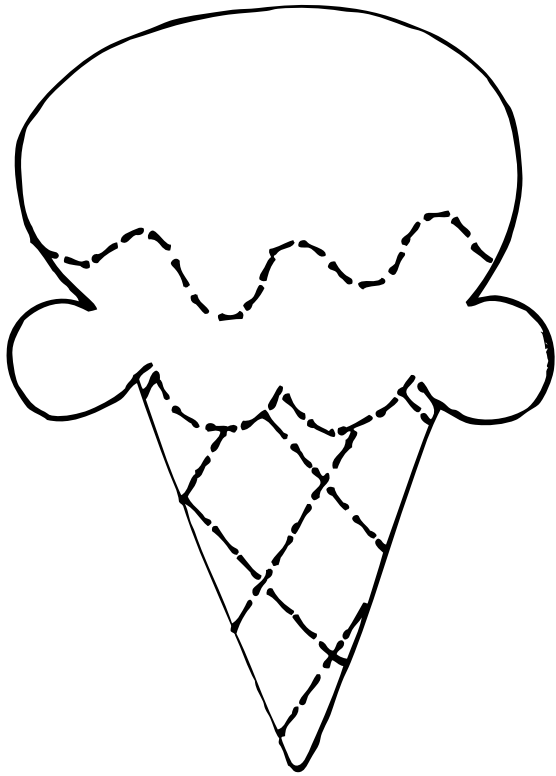

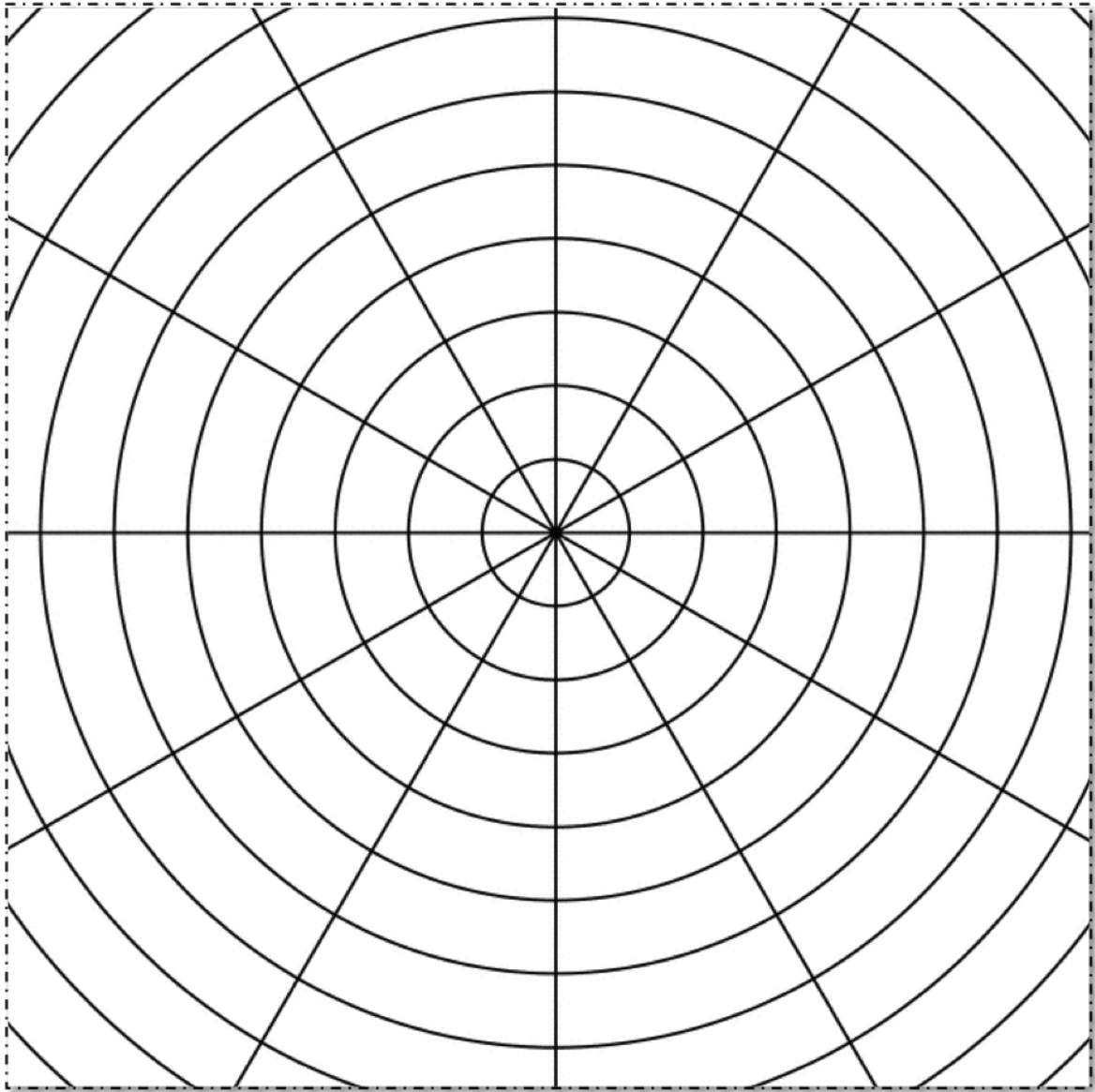
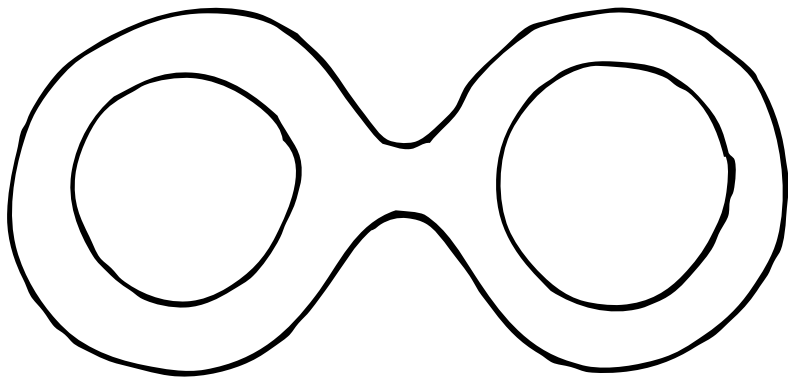
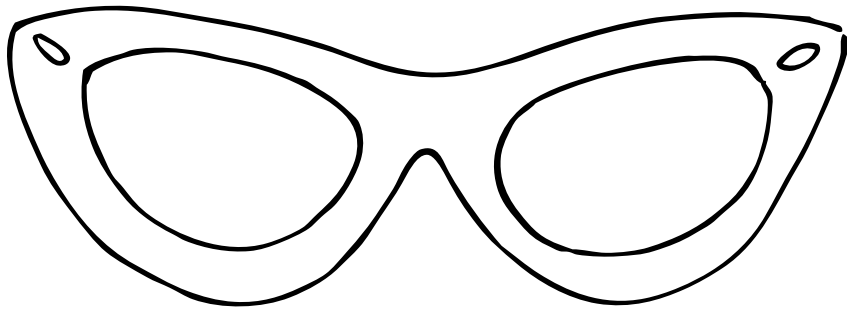
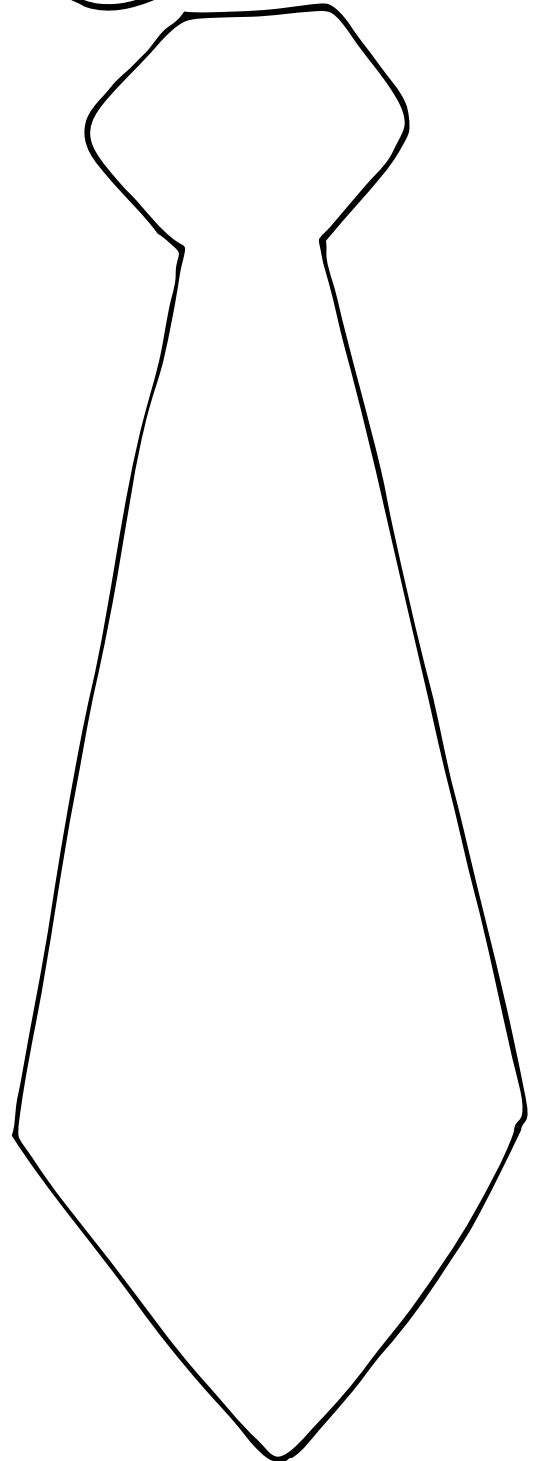
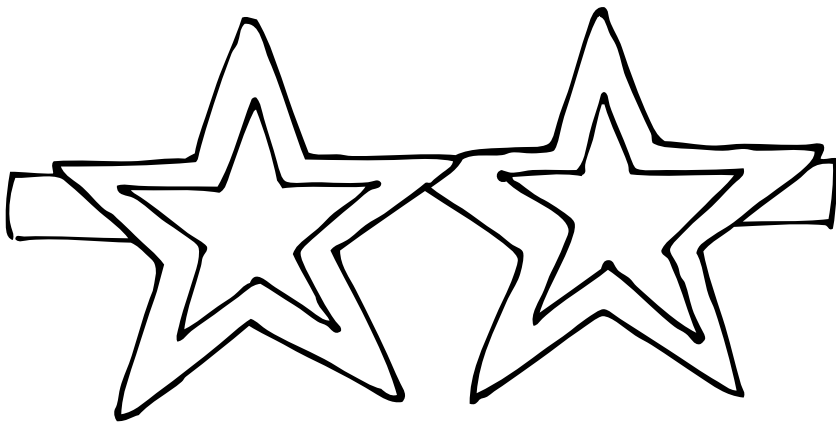
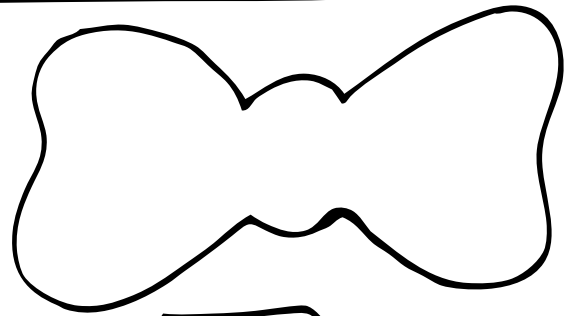
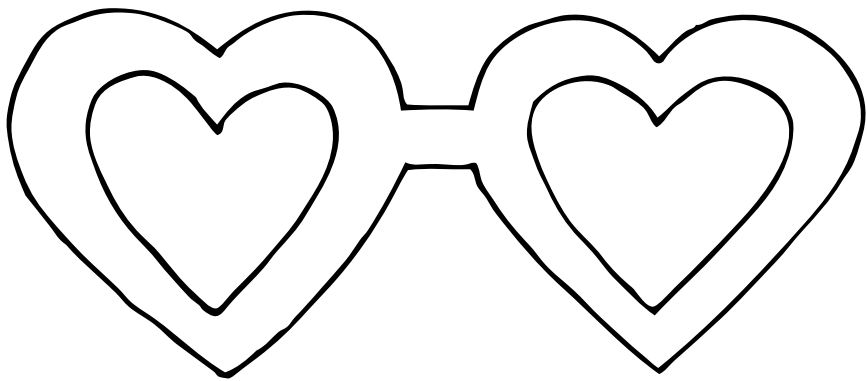
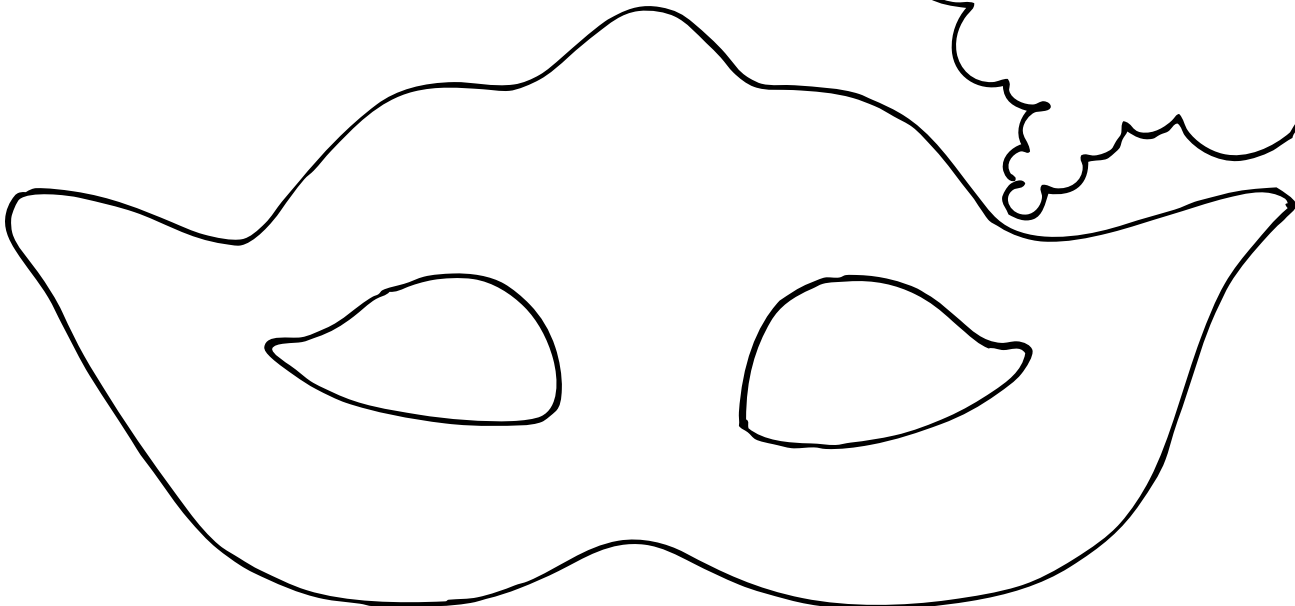
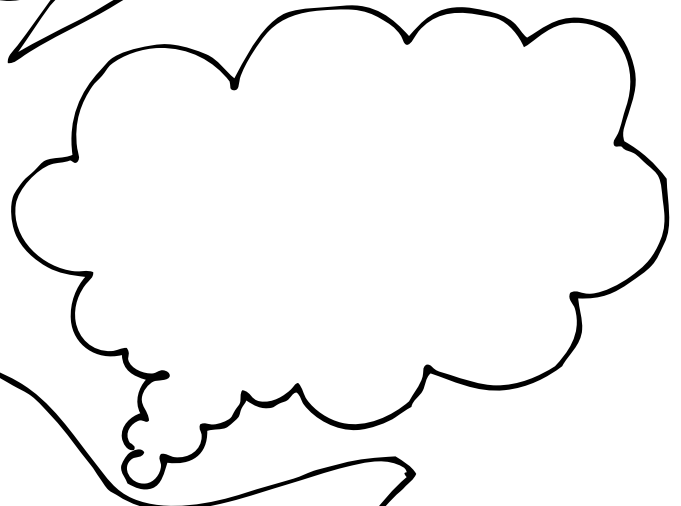
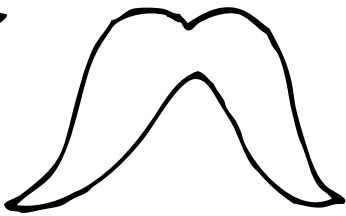
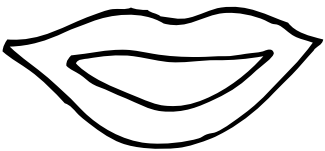
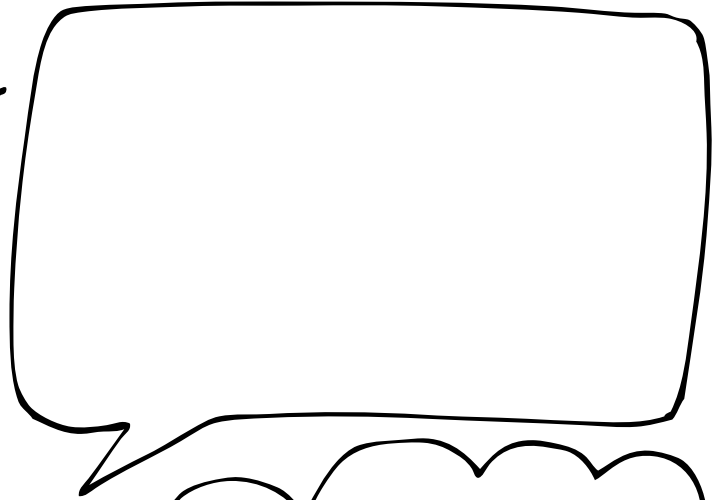
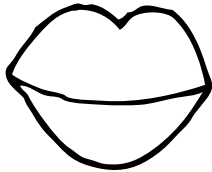
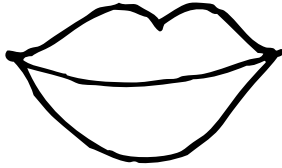
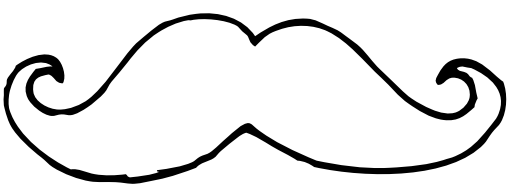
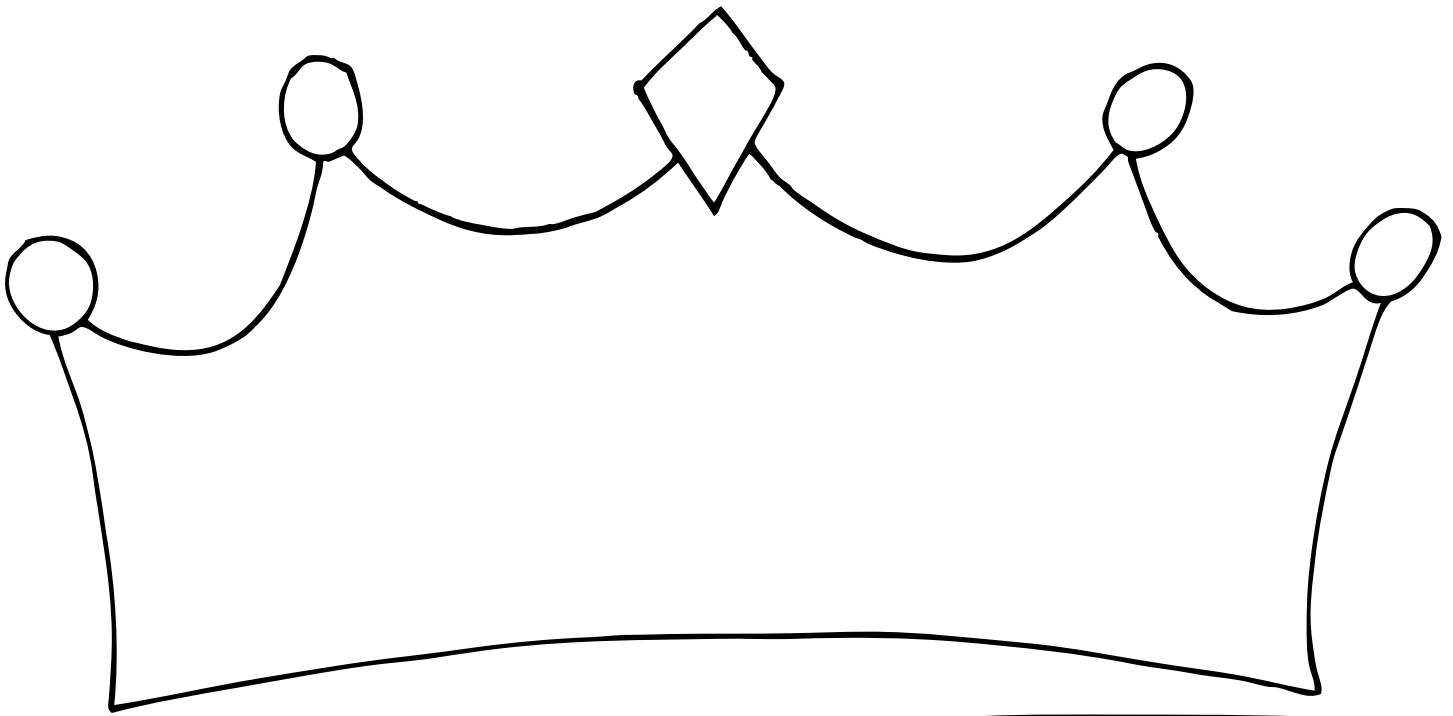

PHOTO BOOTH PROPS





Selfie **DICE GAME**

	ROLL #1	ROLL #2	ROLL #3	ROLL #4
	MOUTH	EYES & NOSE	HAIR	ACCESSORY
